

VZXF-L-M22C-M

Angle seat valve

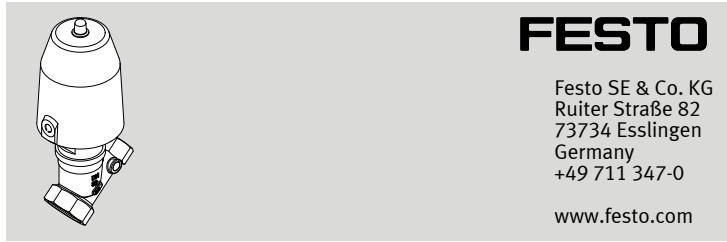

Instructions | Operating

8092242
2018-06b
[8092244]



Translation of the original instructions

1 About this document

This document describes the use of the above-mentioned product.

1.1 Further applicable documents

All available documents for the product → www.festo.com/pk.

2 Safety

2.1 General safety instructions

- Only use the product in original status without unauthorised modifications.
- Only use the product if it is in perfect technical condition.
- Observe labelling on the product.
- Use the valve only in the flow direction indicated.
- Take into consideration the ambient conditions at the location of use.

Media

- Only use media in accordance with the specifications → 14 Technical data.
- Do not operate the product with chemically unstable gases, abrasive media or solid materials.
- If water is used: up to approx. 1000 ppm of chloride content is permitted. Avoid tensile stresses.
- If aggressive media are used: limit temperature of medium to 65 °C.

Return to Festo

Hazardous substances can endanger the health and safety of personnel and cause damage to the environment. To prevent hazards, the product should only be returned upon explicit request by Festo.

- Consult your regional Festo contact.
- Complete the declaration of contamination and attach it to the outside of the packaging.
- Comply with all legal requirements for the handling of hazardous substances and the transport of dangerous goods.

2.2 Intended use

The VZXF angle seat valve is intended to control gaseous or liquid media in rigid piping systems.

- To control liquid media, use only the product variant VZXF-L-M22C-M-B... (closing against the direction of medium flow).

2.3 Training of qualified personnel

Work on the product should only be conducted by qualified personnel. The qualified personnel must be familiar with installation of process automation systems.

3 Further information

- Accessories → www.festo.com/catalogue.
- Spare parts → www.festo.com/spareparts.

4 Service

Contact your regional Festo contact person if you have technical questions → www.festo.com.

5 Product overview

5.1 Design

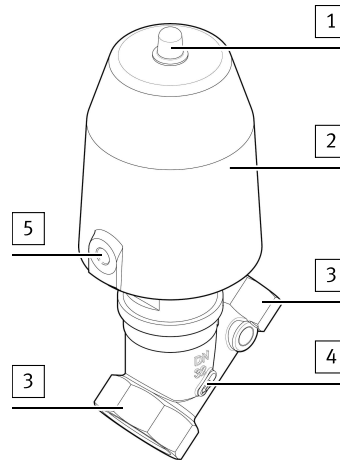

- 1 Position indicator
- 2 Actuator
- 3 Pipe connection with female thread; feed or forwarding (corresponding to flow direction)
- 4 Arrow for direction of flow
- 5 Operating medium port

Fig. 1 Product design

5.2 Product variants and type code

i

The following section explains selected product characteristics that are necessary to understand the instruction manual. Description of the complete type code → www.festo.com/catalogue.

| Characteristic | Value | Description |
|-----------------------------|--------------------|---|
| Type | VZXF | Angle seat valve, externally controlled |
| Valve type | L | In-line valve |
| Valve function | M22C | 2/2-way valve, normally closed |
| Reset method | M | Mechanical spring |
| Flow direction | A | Over valve seat, for gaseous media |
| | B | Under valve seat, for gaseous and liquid media |
| Cable connection | G12 ... G2 | Thread G1½" ... G2" |
| | N12 ... N2 | Thread NPT½" ... NPT2" |
| Nominal width | 120 ... 450 | 12 mm ... 45 mm |
| Temperature range of medium | – | –10 ... +80 °C (standard) |
| | M1 | –40 ... +200 °C |
| Housing material | H3 | Red brass |
| | V4 | Stainless steel |
| Actuator housing material | AL, AN, B1, B2, V4 | Aluminium; nickel-plated aluminium; brass; nickel-plated brass; stainless steel |
| Stem seal material | –, T, V | Standard (NBR), PTFE, FPM |
| Actuator size | 50, 80 | 50 mm, 80 mm |
| Medium pressure | 3 ... 40 | 0 ... 3 bar, ... , 0 ... 40 bar |
| | V | –0.9 ... 0 bar |
| PWIS content | –, C | Standard, PWIS-free |

Tab. 1 Description of key features

5.3 Function

The angle seat valve VZXF-L-M22C-M-... is an externally controlled 2/2-way valve. At rest, the valve is closed by spring force (normally closed - NC). If the actuator is pressurised with operating pressure, it raises the control piston and simultaneously the valve disc. The valve opens.

The valve seat is slanted around 45° toward the media flow.

The supply of the operating medium is controlled by an external valve that must be additionally integrated into the supply cable for the actuator.

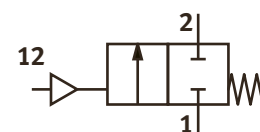

Fig. 2 Circuit symbol

6 Transport and storage

- For delivery of used products: Comply with all legal requirements for the handling of hazardous substances and the transport of dangerous goods. For returns to Festo → 2 Safety.
- Store the product in a cool, dry, UV-protected and corrosion-protected environment. Ensure that storage times are kept to a minimum.

7 Assembly and installation

Requirements

NOTICE!

Avoid mechanical stresses on the valve. Do not use the actuator as a lever.

- The piping is unpressurized, and no medium flows in it.
- The line ends are mounted.
- Connecting cables and fittings are clean.
- An additional 3/2-way valve is built into the supply cable of the operating medium.



Recommendation: For gentle operation, install a flow control valve (1.5 mm) in the supply cable of the operating medium.

Cleaning the valve

- Remove all transport packaging. The material used in the packaging has been specifically chosen for its recyclability (exception: oil-impregnated paper = residual waste).

Traces of residual grease may be evident on the product due to the production process used.

- Clean the valve immediately before installation.

Connect lines

- Bring the valve into its mounting position.
 - Observe the flow direction. The permitted direction of flow is marked by an arrow on the valve housing → Fig.1, [4].
- Connect the piping on the valve housing.
 - Tightening torque → Tab. 2 Tightening torque pipe connection.
- Connect the operating medium line.
 - Tightening torque: max. 26 Nm

| Connection size | [""] | 1/2 | 3/4 | 1 | 1 1/4 | 1 1/2 | 2 |
|--|------|-----|-----|-----|-------|-------|-----|
| Max. tightening torque pipe connection | [Nm] | 105 | 200 | 350 | 450 | 540 | 620 |

Tab. 2 Tightening torque pipe connection

8 Commissioning

Requirements

- The valve is fully mounted and connected.

Checking operating conditions

- Check operating conditions and limit values → 14 Technical data.
- Check connection points for tightness.
- Check compatibility of the devices in the system for maximum pressure (consider pressure peaks). If necessary, adjust the application parameters.

Commissioning the valve

- Supply medium.
- Slowly apply operating pressure to the valve. The operating pressure required for reliable switching of the valve depends on the medium pressure → 14.2 Technical data, pneumatic.
 - The valve opens.

9 Operation

WARNING!

Risk of injury from touching hot surfaces.

Valve housing and actuator can become hot at high temperature of medium. Severe burns are possible.

- Do not touch the angle seat valve during operation or immediately afterward.

- Comply with operating conditions.
- Comply with maintenance conditions → 10 Maintenance.

After longer idle times:

- Actuate the valve several times and check for correct function.

10 Maintenance

WARNING!

Risk of injury from touching hot surfaces.

Valve housing and actuator can become hot at high temperature of medium. Severe burns are possible.

- Allow the angle seat valve to cool off before working on it.

- Check product regularly from the outside for leakage and function.
- Check function of the product regularly.
- Clean product regularly with commercial cleaning agents.

11 Malfunctions

| Fault description | Cause | Remedy |
|-----------------------------------|--|---|
| The valve does not close. | The valve is faulty. | Replace the valve. |
| | The flow direction is incorrect | Replace the valve. |
| | Operating pressure is still present or is too high | Check operating pressure and adjust it, if necessary. |
| The valve does not open. | The valve is faulty. | Replace the valve. |
| | Medium pressure is too high. | Adjust medium pressure. |
| | Operating pressure is too low. | Check operating pressure and adjust it, if necessary. |
| Medium leaks from a leakage hole. | The valve is faulty. | Replace the valve. |

Tab. 3

12 Disassembly

WARNING!

Risk of injury from combustion and chemical burns.

The media in the piping system and the valve can be hot and under pressure. Traces of medium can remain in the product and can escape when open or dismantled.

- Allow the valve and piping to cool and depressurize them.
- Wear specified protective equipment.

NOTICE!

The disassembly of the actuator and valve body is not permitted.

- Depressurize the piping and the connecting cable of the operating medium. Allow the valve and piping to cool.
- Empty the piping and valve completely.
 - Make sure no one is located in front of the outlet opening.
 - Catch discharging media in a suitable container.
- Disconnect the connecting cable of the operating medium from the valve.
- Disconnect the piping connections and remove the valve.

13 Disposal

- Dispose of the product in an environmentally friendly manner. In doing so, take the remaining media into account (use of problematic materials if applicable)
- Observe the local regulations for environmentally friendly disposal.

14 Technical data

14.1 Technical data, general

| Type | VZXF-L-M22C-M |
|--------------------------------------|---|
| Design | Piston actuator with poppet valve |
| Actuation type | Pneumatic |
| Sealing principle | Soft |
| Mounting position | Any |
| Type of mounting | In-line installation |
| Valve function | 2/2-way, closed, monostable |
| Flow direction | Non-reversible |
| Exhaust function | Without flow control option |
| Reset method | Mechanical spring |
| Type of control | Externally controlled |
| Product weight | → www.festo.com/catalogue |
| CE marking | In accordance with declaration of conformity → www.festo.com/sp |
| Medium | |
| Medium VZXF-...-A | Compressed air grade of filtration 200 µm, inert gases, vapour ¹⁾ |
| Medium VZXF-...-B | Compressed air grade of filtration 200 µm, inert gases, water, neutral liquid media, petroleum, petroleum based hydraulic fluid, vapour ¹⁾ |
| Medium pressure | [bar] -0,9 ... 40, in accordance with information on product labelling |
| Viscosity | [mm ² /s] ≤ 600 |
| Operating medium | |
| Operating medium | Compressed air to ISO 8573-1:2010 [7:4:4] |
| Operating pressure | [bar] 6 ... 10 → 14.2 Technical data, pneumatic |
| Temperature | |
| Temperature of medium (NBR, FKM) | [°C] -10 ... +80 |
| Temperature of medium (PTFE) | [°C] -40 ... +200 |
| Perm. min./max. temp (TS) (NBR, FKM) | [°C] -10 ... +80 |
| Ambient temperature | [°C] -10 ... +60 |

| Type | VZXF-L-M22C-M |
|-------------------|---|
| Note on materials | |
| VZXF-...-H3AL | Housing: red brass; actuator: aluminium |
| VZXF-...-H3B1 | Housing: red brass; actuator: brass |
| VZXF-...-V4AN | Housing: stainless steel; actuator: nickel-plated aluminium |
| VZXF-...-V4B2 | Housing: stainless steel; actuator: nickel-plated brass |
| VZXF-...-V4V4 | Housing: stainless steel; actuator: stainless steel |
| Stem seal | NBR (standard), PTFE, FKM |
| Seat seal | PTFE (standard) FKM (vacuum design, PWIS-free) |

1) other media on request

Tab. 4 Technical data, general, VZXF

14.2 Technical data, pneumatic

Nominal pressure and flow rate of process valve

| Connection size | [""] | 1/2 | 3/4 | 1 | 1 1/4 | 1 1/2 | 2 |
|--|--------|---------|---------|-------|-----------|-----------|-------|
| Pipe thread in accordance with DIN ISO 228 | | G 1/2 | G 3/4 | G 1 | G 1 1/4 | G 1 1/2 | G 2 |
| Pipe thread in accordance with ANSI B 1.20.1 | | NPT 1/2 | NPT 3/4 | NPT 1 | NPT 1 1/4 | NPT 1 1/2 | NPT 2 |
| Pneumatic connection | | G 1/8 | | | | | |
| Connection size DN | | 15 | 20 | 25 | 32 | 40 | 50 |
| Nominal pressure of process valve PN VZXF-...-H3 | [bar] | 16 | | | | | |
| Nominal pressure of process valve PN VZXF-...-V4 | [bar] | 40 | | | | | |
| Flow rate $K_v^{1)}$ | | | | | | | |
| VZXF-...-A-...-H3...-50 | [m³/h] | 3.5 | 6.7 | 10.8 | 19 | 23 | 28 |
| VZXF-...-B-...-H3...-50 | [m³/h] | 3.7 | 5.2 | 9.6 | 6 | 16.5 | 23 |
| VZXF-...-A-...-V4...-50 | [m³/h] | 3.8 | 7.5 | 12 | 18.5 | 25 | 34.5 |
| VZXF-...-B-...-V4...-50 | [m³/h] | 3.3 | 6.5 | 11 | 10.7 | 17.5 | 19.5 |
| VZXF-...-A-...-H3...-80 | [m³/h] | - | - | 12 | 21.5 | 30.5 | 40 |
| VZXF-...-B-...-H3...-80 | [m³/h] | - | - | 14.5 | 19 | 29.5 | 30 |
| VZXF-...-A-...-V4...-80 | [m³/h] | - | - | 12.5 | 19 | 29 | 47.5 |
| VZXF-...-B-...-V4...-80 | [m³/h] | - | - | 12 | 17.5 | 28 | 39 |

1) water, at + 20 °C, medium pressure 1 bar at the valve input, free outlet

Tab. 5 Technical data, pneumatic, VZXF

Operating pressure and medium pressure VZXF-...-A-... (medium flow under valve seat)

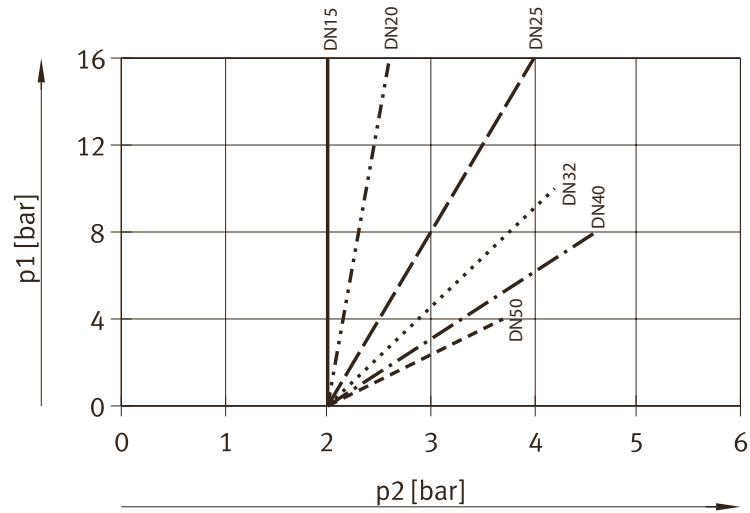

p1 Medium pressure

p2 Operating pressure

Fig. 3 Operating pressure and medium pressure VZXF-...-A-...-H3B1-...-50

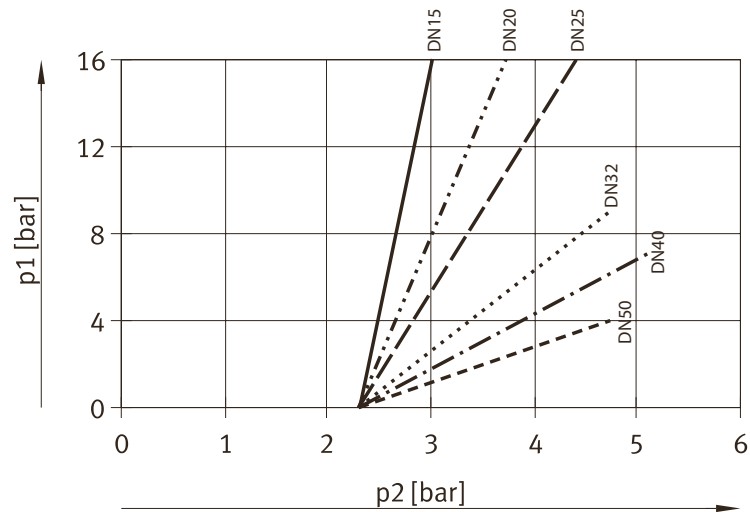

p1 Medium pressure

p2 Operating pressure

Fig. 4 Operating pressure and medium pressure VZXF-...-A-...-V4V4-...-50

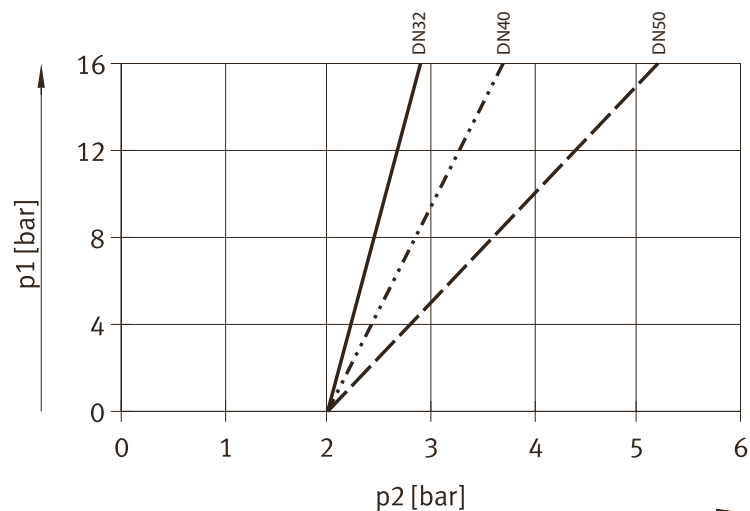

p1 Medium pressure

p2 Operating pressure

Fig. 5 Operating pressure and medium pressure VZXF-...-A-...-H3AL-...-80

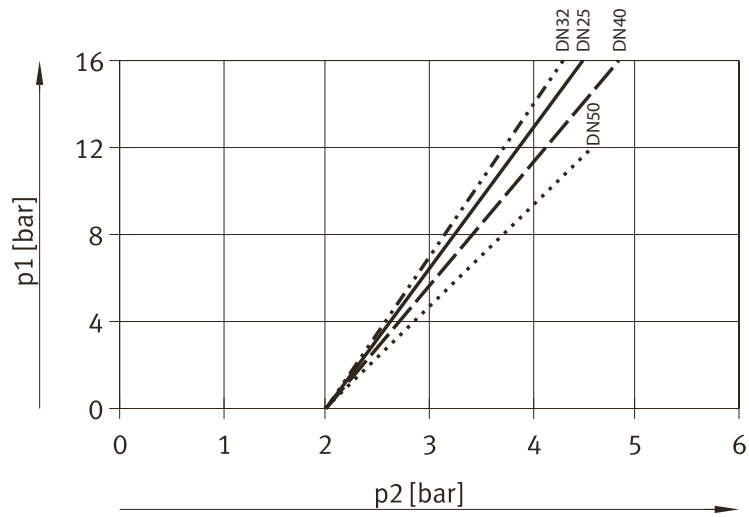

p1 Medium pressure p2 Operating pressure
 Fig. 6 Operating pressure and medium pressure VZXF-...-A-...-V4V4-...-80

Operating pressure and medium pressure VZXF-...-B (medium flow under valve seat)

| VZXF | | DN15 | DN20 | DN25 | DN32 | DN40 | DN50 |
|--------------------------------|-------|------|------|------|------|------|------|
| VZXF-...-B-...-H3...-50 | | | | | | | |
| Min. operating pressure | [bar] | 4.9 | 4.5 | 5.3 | 5.5 | 5.8 | 5.7 |
| Max. medium pressure | [bar] | 16 | 16 | 10 | 7 | 6 | 3 |
| VZXF-...-B-...-V4...-50 | | | | | | | |
| Min. operating pressure | [bar] | 5.3 | 5.5 | 5.5 | 5.5 | 5.5 | 5.5 |
| Max. medium pressure | [bar] | 40 | 20 | 10 | 7 | 6 | 3 |
| VZXF-...-B-...-H3...-80 | | | | | | | |
| Min. operating pressure | [bar] | - | - | 4.0 | 4.2 | 4.3 | 4.3 |
| Max. medium pressure | [bar] | - | - | 16 | 12 | 8 | 5 |
| VZXF-...-B-...-V4...-80 | | | | | | | |
| Min. operating pressure | [bar] | - | - | 4.1 | 4.1 | 4.1 | 4.1 |
| Max. medium pressure | [bar] | - | - | 22 | 10 | 8 | 5 |

Tab. 6 Operating pressure and medium pressure, VZXF-...-B