

R623G10

printed on: 15-12-2023



TECHNICAL INFO

Media type	INORGANIC FIBERGLASS
Efficiency	10 $\mu\text{m}_{(c)}$ $\beta_x \geq 200$
Efficiency 1	12 $\mu\text{m}_{(c)}$ $\beta_x \geq 1000$
Flow direction	OUT-IN
Collapse Δp	10 bar
Bypass setting	2.5 bar
Seals	NBR
Temperature range	-30°C +100°C

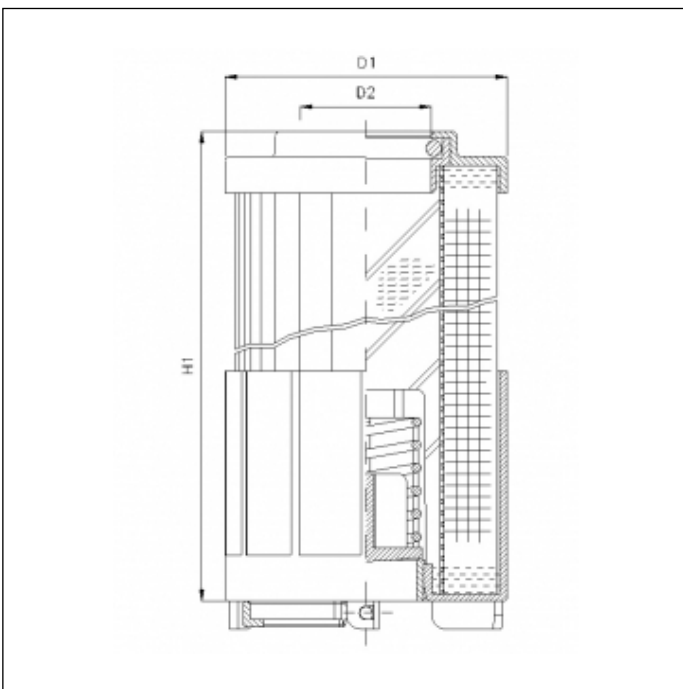

OVERALL DIMENSIONS

D1	61,5 mm
D2	28,5 mm
H1	200,0 mm

Technical information may change without notice. Image and drawing are representative only