

DIRECT OPERATED CHECK VALVE TYPE ERM203...
EINFACHE RUECKSCHLAGVENTIL TYP ERM203...

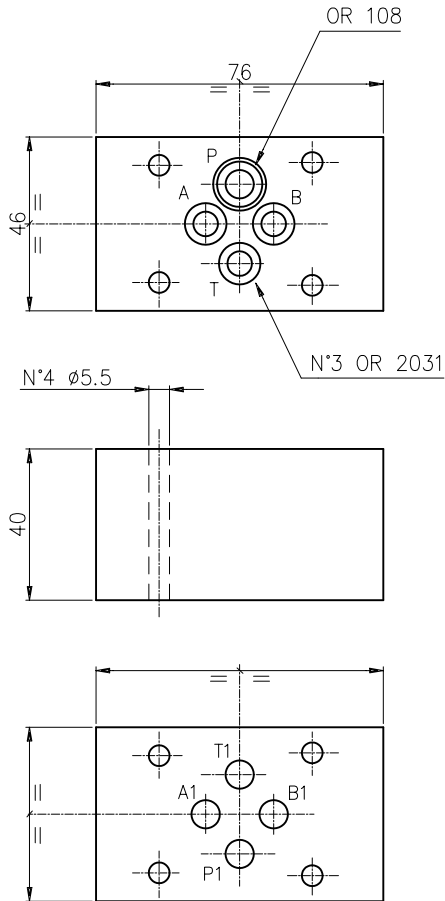

Direct operated check valves for modular mounting
 Einfache Rueckschlagventil fuer Modularmontage
 Weight / Gewicht = 0.9 Kg

Type/Typ ERM203P



Max pressure
 Druck
 300 bar

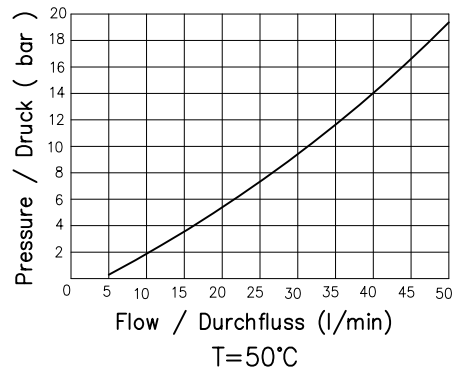

checking on / Funktion in AB

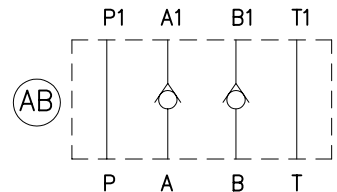

checking on / Funktion in A

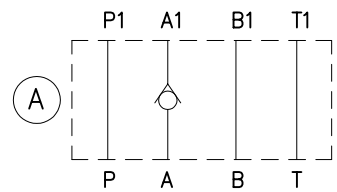

checking on / Funktion in B

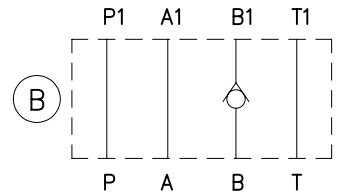

checking on / Funktion in P

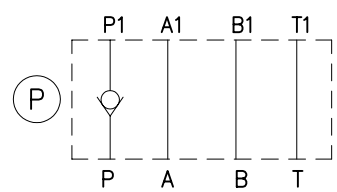

checking on / Funktion in T

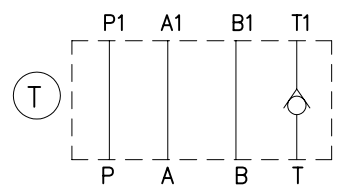

Ordering code
 Bestell-Code

E R M 20 3 *

EUROFLUID =

Check valve = R
 Rueckschlagventil

type of Modular mounting = M
 Typ fuer Modularmontage

Direct operated = 20
 Einfaches Rueckschlagventil

CETOP 3 = 3

checking on/Einstellung :

VALVES
 VENTILE