



CE Made in Italy



CATALOGUE CABLE REEL and
Air-Water HOSE REEL

No. E15/AE



HELP THE NATURE

Packaging contains, depending on the articles, one or more of the following materials; they must be recycled in accordance with current regulations in the country of use.

cardboard • polyethylene sack • polystyrene • paper • wood • nails
• plastic strap • cellophane • clips • gummed paper



OUR STRENGTHS

The widest range of cable reels and hose reels designed to meet all the needs of our clients, even the most specific.

The quality, reliability and design that have always distinguished the Ecodora brand in the global market.

The research and development as a flagship of our company to always offer cutting-edge solutions.

A technical service before and after sales to recommend the most suitable product according to the customer's needs as well as to provide support to the end users.

OUR AIMS

To develop a long lasting cooperation with our customers by listening to their needs and their expectations.

To meet every user's need by offering only high quality products.

www.ecodora.com
info@ecodora.com

CE Made in Italy



OUR AIMS

The use of the best Technical and project skills in order to offer to the customers, everywhere all over the world, excellence products only.

www.ecodora.com
info@ecodora.com







TECHNICAL CHARACTERISTICS	page 9
USE OF ADJUSTABLE BRACKET	page 10
ACCESSORIES	page 11
ELECTRICAL CABLES	page 12

CABLE REEL Series 280

Series 280 - 230 V SINGLE-PHASE Without Socket	page 14
Series 280 - 400 V THREE-PHASE Without Socket	page 16
Series 280 - 230 V SINGLE-PHASE With single socket and "shucko" - IP44 With triple socket and "shucko" - IP44	page 18



CABLE REEL Series 280 - 290 WITH LAMP

Series 280 - Without transformer With fluorescent portable lamp 11W Series F230 - F12 - F24	page 20
Series 280 - Without transformer With portable LED lamp Series L1224	page 22
Series 290 - With 230 V transformer With portable LED lamp Series L1224	page 24



LAMPS

TECHNICAL CHARACTERISTICS	page 29
Portable lamp Series F230 - F12 - F24 Equipped with fluorescent light bulb	page 30
Portable lamp Series L1224 Equipped with LED holder unit	page 31



EARTHING CABLE REEL Series 280 - 350

OPERATION	page 33
Enclosed cable reel Series 280 Earthing	page 34
Earthing cable reel Series 350	page 36
TECHNICAL CHARACTERISTICS	page 37



ENCLOSED HOSE REEL Series 280

TECHNICAL CHARACTERISTICS	page 39
ENCLOSED HOSE REEL Series 280 Air-Water 20 bar - 40 °C	page 40

Cable reel presentation

All ECODORA cable reels rewind automatically and are equipped with a spring tested for tens of thousands of cycles which ensure a constant force. They are sturdy, compact, easy to position and removable. They allow managing with extreme ease and safety electrical cables of various sizes and cross sections ensuring a tidy and safe work environment.

All models are equipped with:

- ▶ Rewinding spring.
- ▶ Cable stop rack work.
- ▶ Protective shell in shockproof material.
- ▶ Cable guide with rollers.
- ▶ Fixing bracket.
- ▶ System for the manual reset of electrical power (to prevent damage from eventual overloads) with rewinded cable.
- ▶ Inlet cable for connection to the mains.

Accessories

Each model of ECODORA cable reel is customizable with the following accessories: Fixing bracket with "bayonet" coupler, protection cap, rewinding' clutch.

ADVANTAGES

- ▶ Electric collector designed for better performances also with high currents.
- ▶ Thermal protector against overheating of the rewinded cable mounted in all the models.
- ▶ IP44 protection degree provided for all the electrical parts.
- ▶ Spring tested for more than 10 working years with the possibility to easily adjust the rewinding force.
- ▶ Cable guide with rollers equipped with 4 rollers in each model designed to save the work life of the cable.
- ▶ Different options for different needs: rewinding clutch, bayonet bracket and protection cap.



CABLE REEL

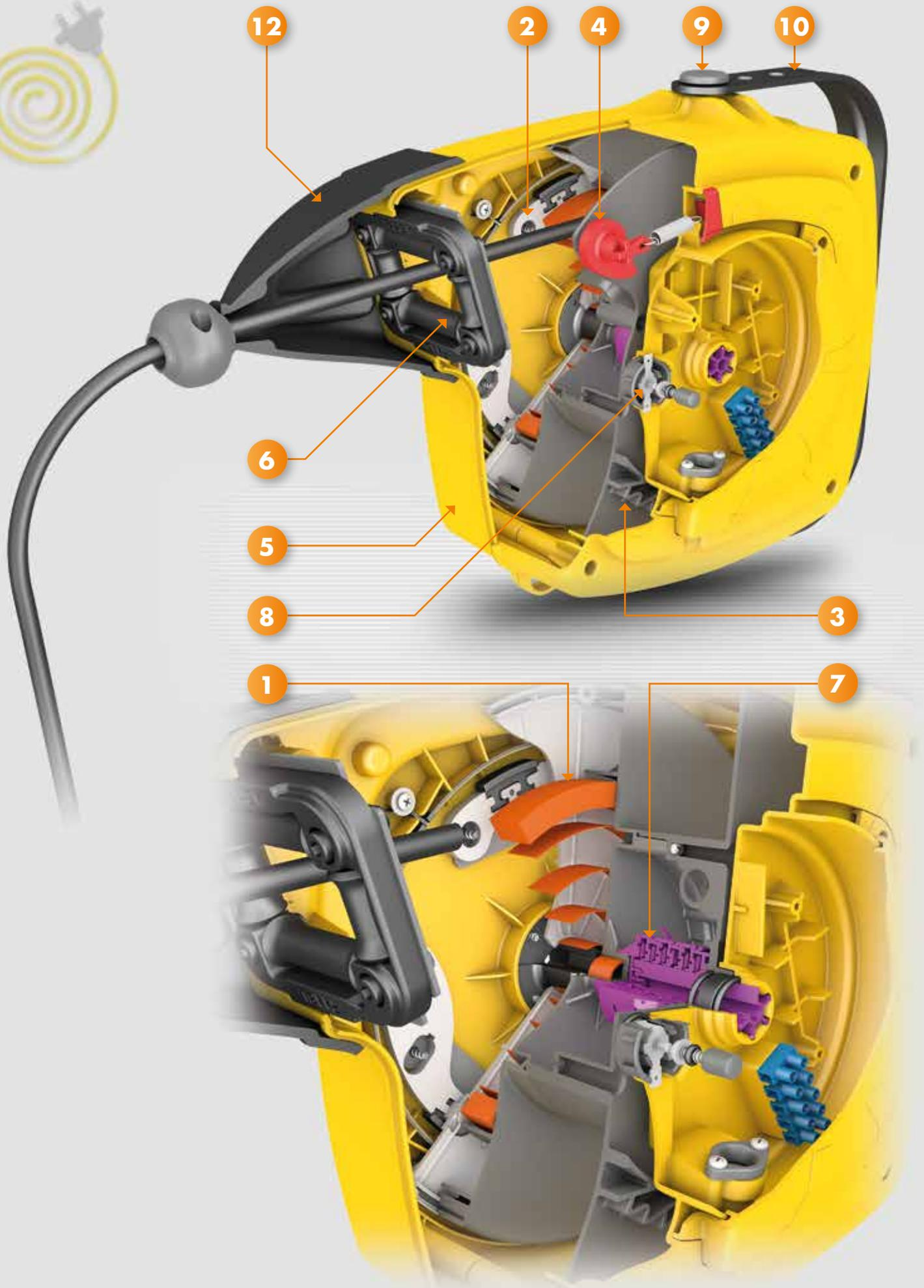

Technical characteristics



- 1 SPRING**

Rewinding spring totally protected from the external environment. The spring is subjected to a durability test of 20000 cycles (each cycle corresponds to the complete unwinding and rewinding of the cable) thus simulating an average life of over 10 years. Possibility to intervene to adjust the spring force increasing or decreasing the preload.
- 2 REWINDING CLUTCH**

Optional, devoid of complex and potentially wearing kinematic motions, allows the rewinding of the drum at a safe speed.
- 3 STOPPING RACK**

It has an increased width and reinforcement ribs ensuring greater durability and sturdiness. It offers the possibility to block the cable every 0.5 m. allowing the unwinding of the desired length.
- 4 PAWL**

Easy to remove, of increased thickness with reinforcing ribs ensuring high stress resistance and durability.
- 5 STRUCTURE**

Strong and compact made in shockproof material of high mechanical resistance designed to withstand over time.
- 6 CABLE GUIDE WITH ROLLERS**

Sturdy and resistant with reinforced steel interior. Wide width which allows guiding the cable properly for correct rewind. Equipped with 4 rollers, 2 arranged horizontally (above and below) and 2 arranged vertically (left and right) that reduce cable wear.
- 7 ELECTRIC COLLECTOR**

Replaceable in one single piece, it has sliding contacts each provided with 3 sliding lines to reduce the electrical resistance and the heating during operation. Equipped with double earth contact.
- 8 THERMAL PROTECTOR**

Safety system against overheating of the rewinded cable.
- 9 SIDE CLUTCH**

The bracket is equipped with a special clutch which controls the rotation speed on the right and on the left of the cable reel.
- 10 ADJUSTABLE BRACKET**

Adjustable up to 90 ° per side, constructed with sturdy structure, with fixing slotted holes that facilitate wall mounting.
- 11 BAYONET BRACKET**

A bracket with bayonet type quick coupling is available on request: it allows an easier movement of the cable reeler in the various workstations.
- 12 PROTECTION CAP**

In NBR synthetic rubber, it protects the cable reel from accidental entrance of foreign bodies through the cable guide.

USE OF ADJUSTABLE BRACKET

POSITION 1

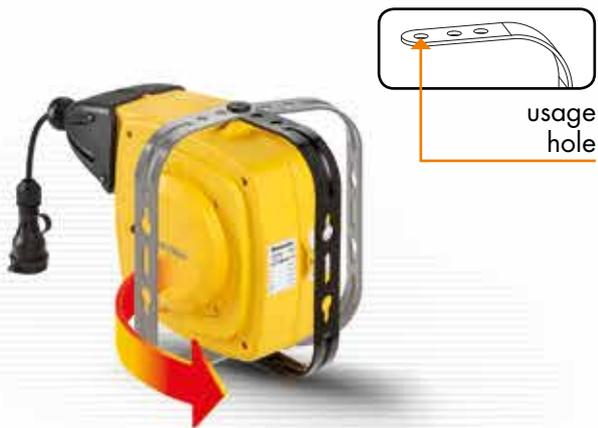

The adjustable bracket of the cable reel may assume various positions:

The **position 1** is particularly suitable for "single" installation on the wall or ceiling. This position allows the rotation of the cable reel around the central axis supported by the bracket, allowing maximum flexibility to the operator in the use of the cable in all directions.

POSITION 2

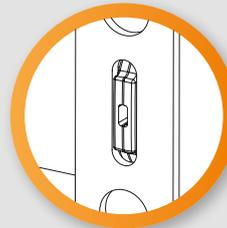

The **position 2** is suitable for installation of the cable reel "in series" (ceiling wall / floor or bench) because the rotation is blocked by the bracket that creates an interlocking with the guards of the cable reel.

POSITION 3



The **position 3** is suitable for specific installation schemes, that is when the pulling and exit direction of the cable is parallel to the wall where the cable reel is installed.

In order to pass from an installation position to another it is necessary to remove the bracket.

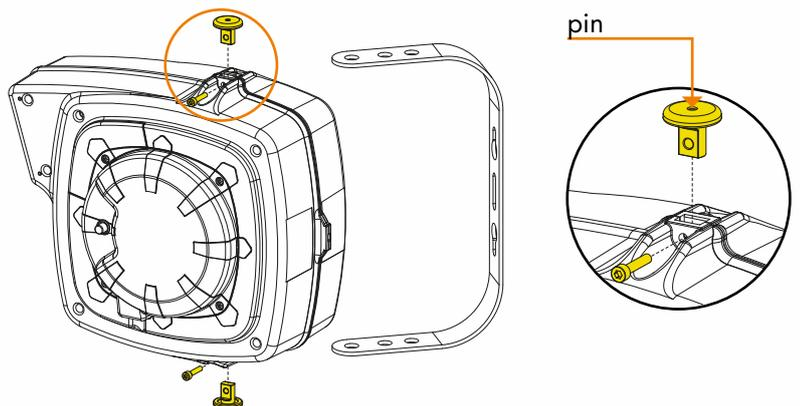

ACCESSORIES

REWINDING CLUTCH

Cable reels Series 280 and Series 290 can be equipped with a brake acting while rewinding the cable. This accessory limits the maximum rotation speed making secure even accidental and uncontrolled rewinding. The version with the clutch, is distinguished from the

“SPEED CONTROL” plate
 **TO BE REQUESTED WITH THE ORDER**



PROTECTION CAP

P/N **0E728115**

The **protection cap** of the cable guide, made of flexible black rubber, prevents accidental entry of foreign bodies and ensures to the cable reeler the IP 45 protection degree.

On request it can be mounted on the cable reel you want to purchase using the appropriate customized code, see the following pages.



BAYONET BRACKET

P/N **260/03**

A bracket with bayonet type quick coupling is available on request: (provided with wall bracket P/N 260/01), it allows an easier movement of the cable reel in the various workstations.

P/N **260/01**

Wall bracket, to be bought separately in case you want to create multiple points for fitting the cable reel provided with bayonet bracket.

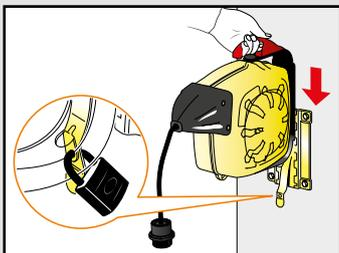

To prevent removal or theft of the cable reel it is possible to secure it with a bolt or a lock.



ELECTRICAL CABLES

The denomination “electrical cable” indicates a conductor uniformly insulated or a set of insulated conductors, each from the others and towards the outside, combined into a single complex complete with protection covering.

THE CABLE IS MADE OF SEVERAL PARTS:

- ▶ The metallic part for conducting the current consists of a single wire or several stranded wires and their conductor.
- ▶ A layer of insulating material surrounds the conductor.
- ▶ The set of the conductor and its isolation constitutes the cable core; each cable may have more cores.
- ▶ The sheath has a protective function of the cable cores. The sheath in general is always in insulating material.

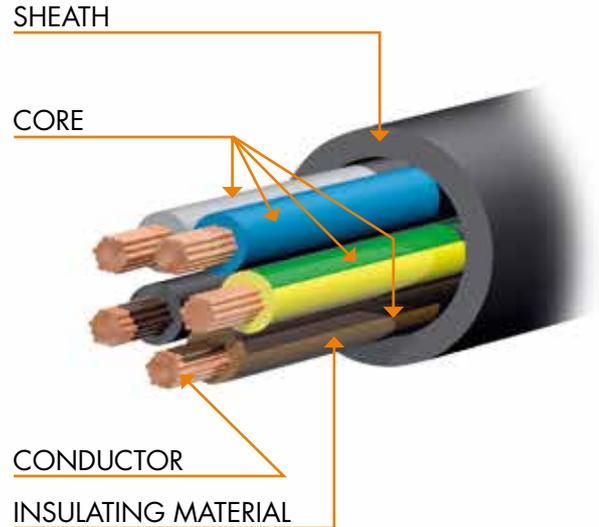

TECHNICAL TABLE READING GUIDE

NUMBER OF CONDUCTORS	Number of conductors uniformly insulated that make up the cross section of the electrical cable.
CONDUCTOR'S CROSS SECTION	Area (in mm ²) of the cross section of each conductor.
TYPE OF INSULATING MATERIAL	The type of material (e.g. PVC, natural rubber) acts as a protective covering to the conductor with mechanical or chemical protection function.

The following guidelines have been extracted from the Standard CEI 20-27

EXAMPLE OF POWER CABLE DESIGNATION



Number of conductors and conductor cross section (in mm²)

2 x 1 2 Conductors cable, cross section 1 mm²

- 3G x 1** 3 Conductors, cross section 1 mm² each, one of them with yellow-green insulation
- 4G x 1** 4 Conductors, cross section 1 mm² each, one of them with yellow-green insulation
- 5G x 1** 5 Conductors, cross section 1 mm² each, one of them with yellow-green insulation

Reference Standards

- H** Cable conforming to Harmonized standards CENELEC (HD 22.4 S2)
- A** Cable of national type approved and listed in the supplements to the Harmonized standards CENELEC
- xx - N** Other type of national cable

Voltage rating

- 03** Rated insulation voltage U₀/U = 300/300V
- 05** Rated insulation voltage U₀/U = 300/500V
- 07** Rated insulation voltage U₀/U = 450/750V
- 1** Rated insulation voltage U₀/U = 0,6/1KV

Insulation material

- B** Ethylene propylene rubber
- B3** Butyl rubber
- J** Braided fiberglass
- M** Mineral
- N** Polychloroprene (or equivalent material)
- R** Natural rubber or styrene-butadiene rubber
- S** Silicone rubber
- V** Polyvinyl chloride (PVC) commonly used
- X** Cross-linked polyethylene

Non-metallic sheath

- B** Ethylene propylene rubber
- B3** Butyl rubber
- J** Braided fiberglass
- M** Mineral
- N** Polychloroprene (or equivalent material)
- R** Natural rubber or styrene-butadiene rubber
- S** Silicon rubber
- V** Polyvinyl chloride (PVC) commonly used
- X** Cross-linked polyethylene

Conductor form

- F** Flexible conductor of a flexible cable for mobile service
- H** Highly flexible conductor of a flexible cable for mobile service
- K** Flexible conductor of a cable for fixed installation
- R** Rigid conductor, round, stringed
- S** Rigid conductor, sectorial, stringed
- U** Rigid conductor, round, single-wire



Examples of application sectors

CONSTRUCTION SITE



ECODORA has produced a wide range of industrial cable reels that can meet the most complex and demanding requests for use fields such as industry, agriculture, petrochemical, mining, aeronautics, shipbuilding, fire departments, automotive, construction, etc.

WINERIES AND WINE COMPANIES



Cable reel Series 280

230 V SINGLE PHASE

without socket

Colour:

STANDARD RAL 7035

Structure:

Shockproof plastic material

Stop:

Automatic through rack

Protection degree of electrical part:

IP44 without protection cap
IP45 with protection cap

Attention: The system is downgraded depending on the IP value of the connected components.

Fixing bracket:

Fixed / adjustable

Usage environment

temperature:

-5°C / +40°C



2

EN 61242

2006/95/CE 2004/108/CE
2011/65/UE

3

EN 61242

2006/95/CE 2004/108/CE
2011/65/UE

CABLE REEL - 230 V SINGLE PHASE

Standard cable reel code	Number of conductors	Cable type	Cable length (m)	Cable inlet (m)	Max. power use (20°C)		Thermal protector
					Wound kW	*Unwound kW	
OE728A0/A21171	2	2 x 1 - H05 VV-F	17 + 1	1,2	0,9	1,4	YES
OE728A0/B21121	2	2 x 1 - H07 RN-F	12 + 1	1,2	0,9	1,4	YES
OE728A0/A22151	2	2 x 1,5 - H05 VV-F	15 + 1	1,2	1,1	2,3	YES
OE728A0/A23101	2	2 x 2,5 - H05 VV-F	10 + 1	1,2	1,9	3,5	YES
OE728A0/A31141	3	3G x 1 - H05 VV-F	14 + 1	1,2	0,9	1,4	YES
OE728A0/B31101	3	3G x 1 - H07 RN-F	10 + 1	1,2	0,9	1,4	YES
OE728A0/A32141	3	3G x 1,5 - H05 VV-F	14 + 1	1,2	1,2	2,3	YES
OE728A0/B32091	3	3G x 1,5 - H07 RN-F	9 + 1	1,2	1,2	2,3	YES
OE728A0/A33091	3	3G x 2,5 - H05 VV-F	9 + 1	1,2	1,9	3,5	YES
OE728A0/B33071	3	3G x 2,5 - H07 RN-F	7 + 1	1,2	1,9	3,5	YES

⚠ The following codes are considered devoid of accessories: Rewinding clutch - Protection cap - Bayonet bracket.

* The values are intended with cable completely unwound.

Overall dimensions (mm)

NORMAL

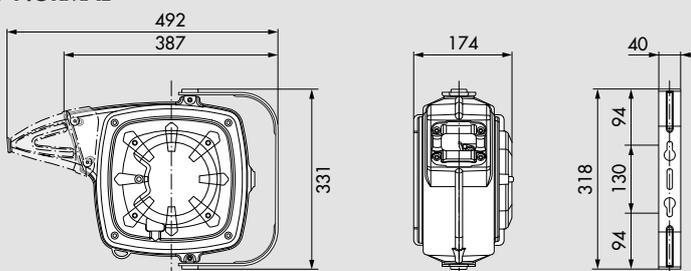

N°1 packing m³ 0,043 from kg 6,4 to 8,2



N°48 packages per pallet

WITH BRACKET

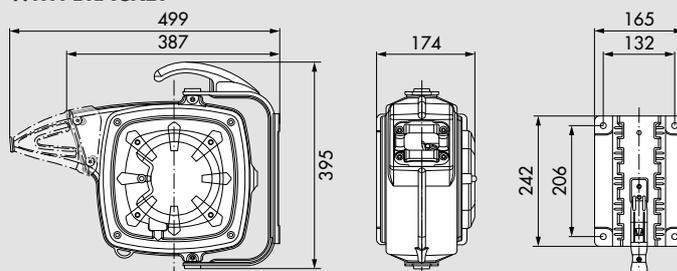

N°1 packing m³ 0,043 from kg 7,0 to 8,8



N°48 packages per pallet

How to customize the cable reel

All cable reel codes shown on the table on the opposite page are not provided with clutch, protection cover and bayonet bracket (see accessories description on page 11). To equip the cable reel with one or more of the above-mentioned accessories you need to modify the code as described in the table below.

⚠ All other technical characteristics are not subject to customization

Example of standard code as indicated in the table on page 14

OE728 **A** **0** / **A** **2** **1** **17** **1**



		0	1	2	3	4	5	6	7
REWINDING CLUTCH		NO	YES	NO	NO	YES	YES	NO	YES
PROTECTION CAP		NO	NO	YES	NO	YES	NO	YES	YES
BAYONET BRACKET		NO	NO	NO	YES	NO	YES	YES	YES

Customizing the cable reel: for example, if you are interested to the cable reel **OE728A0/A21171** but equipped with clutch and protection cap you will have to put number 4 instead of 0 so that the final code of the cable reel will be **OE728A4/A21171**



The version equipped with a clutch that allows rewinding the cable at a controlled rate, is characterized by the plate

“SPEED CONTROL”
TO BE REQUESTED WITH THE ORDER



P/N OE728115

Protection cap, made of oil resistant rubber is useful against the accidental entry of water or foreign objects inside the cable reel.

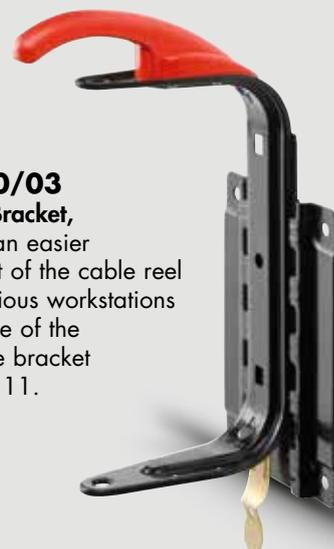

P/N 260/03

Bayonet Bracket, it allows an easier movement of the cable reel in the various workstations For the use of the adjustable bracket see page 11.

Cable reel Series 280

400 V THREE PHASE

without socket

Colour:

 STANDARD  RAL 7035

Structure:

Shockproof plastic material

Stop:

Automatic through rack

Protection degree of electrical part:

IP44 without protection cap

IP45 with protection cap

Attention: The system is downgraded depending on the IP value of the connected components.

Fixing bracket:

Fixed / adjustable

Usage environment

temperature:

-5°C / +40°C







EN 61242

2006/95/CE 2004/108/CE
2011/65/UE

CABLE REEL - 400 V THREE PHASE							
Standard cable reel code	Number of conductors	Cable type	Cable length (m)	Cable inlet (m)	Max. power use (20°C)		Thermal protector
					Wound kW	*Unwound kW	
OE728A0/A41111	4	4G x 1 - H05 VV-F	11 + 1	1,2	1,1	2,3	YES
OE728A0/A42101	4	4G x 1,5 - H05 VV-F	10 + 1	1,2	1,4	4	YES
OE728A0/B42081	4	4G x 1,5 - H07 RN-F	8 + 1	1,2	1,4	4	YES
OE728A0/A43081	4	4G x 2,5 - H05 VV-F	8 + 1	1,2	2	6	YES
OE728A0/B43051	4	4G x 2,5 - H07 RN-F	5 + 1	1,2	2	6	YES
OE728A0/A51111	5	5G x 1 - H05 VV-F	11 + 1	1,2	1	2,3	YES
OE728A0/A52081	5	5G x 1,5 - H05 VV-F	8 + 1	1,2	1,4	4	YES
OE728A0/B52071	5	5G x 1,5 - H07 RN-F	7 + 1	1,2	1,4	4	YES

⚠ The following codes are considered devoid of accessories: Rewinding clutch - Protection cap - Bayonet bracket.

* The values are intended with cable completely unwound.

Overall dimensions (mm)

NORMAL

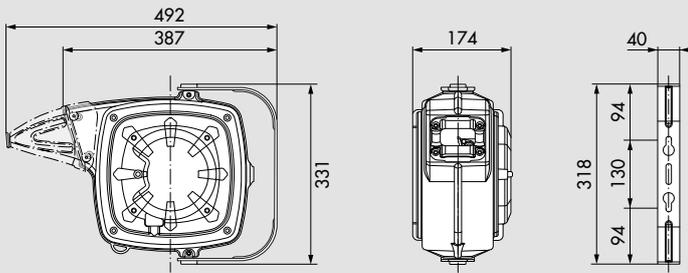

N°1 packing m³ 0,043 from kg 6,4 to 8,4



N°48 packages per pallet

WITH BRACKET

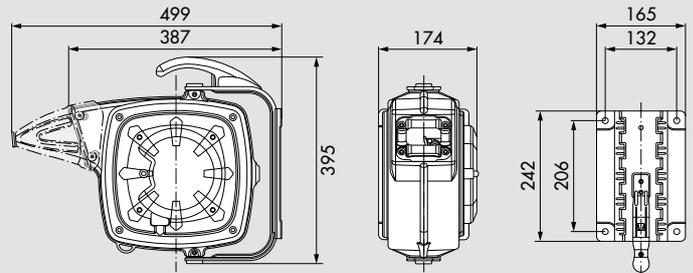

N°1 packing m³ 0,043 from kg 7,0 to 9,0



N°48 packages per pallet

How to customize the cable reel

All cable reel codes shown on the table on the opposite page are not provided with clutch, protection cover and bayonet bracket (see accessories description on page 11). To equip the cable reel with one or more of the above-mentioned accessories you need to modify the code as described in the table below.

⚠ All other technical characteristics are not subject to customization

Example of standard code as indicated in the table on page 16

OE728 **A** **0** / **A** **4** **1** **11** **1**

↑
Accessories

		0	1	2	3	4	5	6	7
REWINDING CLUTCH		NO	YES	NO	NO	YES	YES	NO	YES
PROTECTION CAP		NO	NO	YES	NO	YES	NO	YES	YES
BAYONET BRACKET		NO	NO	NO	YES	NO	YES	YES	YES

Customizing the cable reel: for example, if you are interested to the cable reel **OE728A0/A41111** but equipped with clutch and protection cap you will have to put number 4 instead of 0 so that the final code of the cable reel will be **OE728A4/A41111**



The version equipped with a clutch that allows rewinding the cable at a controlled rate, is characterized by the plate

"SPEED CONTROL"

⚠ **TO BE REQUESTED WITH THE ORDER**



P/N OE728115

Protection cap,

made of oil resistant rubber is useful against the accidental entry of water or foreign objects inside the cable reel.

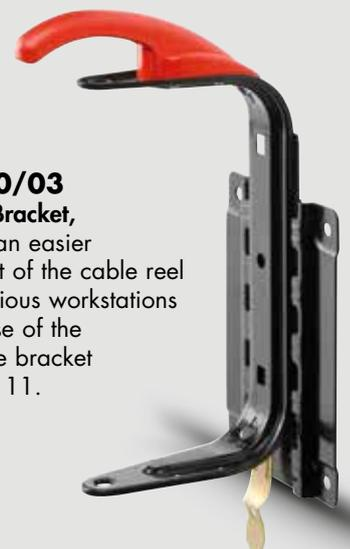

P/N 260/03

Bayonet Bracket,

it allows an easier movement of the cable reel in the various workstations For the use of the adjustable bracket see page 11.

Cable reel Series 280 230 V SINGLE PHASE

with socket and SCHUKO plug IP44

Colour:



Structure:

Shockproof plastic material

Stop:

Automatic through rack

Protection degree of electrical part:

IP44 without protection cap
IP45 with protection cap

Attention: The system is downgraded depending on the IP value of the connected components.

Fixing bracket:

Fixed / adjustable

Usage environment

temperature:

-5°C / +40°C

EN 61242

2006/95/CE 2004/108/CE
2011/65/UE



extension with one socket and universal Schuko plug IP44

extension with triple socket and Schuko plug IP44

CABLE REEL - 230 V SINGLE PHASE with socket and Schuko plug								1 SOCKET
Standard cable reel code	Number of conductors	Cable type	Cable length (m)	Cable inlet (m)	Max. power use (20°C)		Thermal protector	
					Wound kW	*Unwound kW		
OE728A0/A32142	3	3G x 1,5 - H05 VV-F	14 + 1	1,2	1,2	2,3	YES	

CABLE REEL - 230 V SINGLE PHASE with triple socket and Schuko plug								3 SOCKET
Standard cable reel code	Number of conductors	Cable type	Cable length (m)	Cable inlet (m)	Max. power use (20°C)		Thermal protector	
					Wound kW	*Unwound kW		
OE728A0/A32143	3	3G x 1,5 - H05 VV-F	14 + 1	1,2	1,2	2,3	YES	

⚠ The following codes are considered devoid of accessories: Rewinding clutch - Protection cap - Bayonet bracket.

* The values are intended with cable completely unwound.

Overall dimensions (mm)

NORMAL

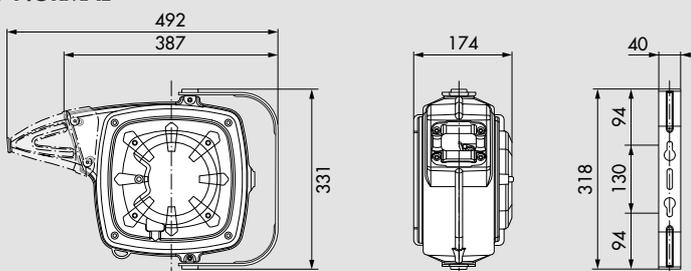

N°1 packing m³ 0,043 from kg 6,6 to 8,8



N°48 packages per pallet

WITH BRACKET

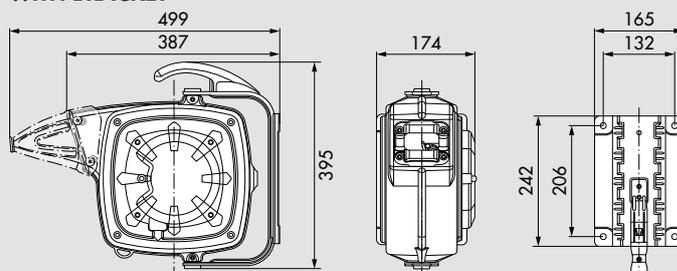

N°1 packing m³ 0,043 from kg 7,2 to 9,4



N°48 packages per pallet

How to customize the cable reel

All cable reel codes shown on the table on the opposite page are not provided with clutch, protection cover and bayonet bracket (see accessories description on page 11). To equip the cable reel with one or more of the above-mentioned accessories you need to modify the code as described in the table below.

⚠ All other technical characteristics are not subject to customization

Example of standard code as indicated in the table on page 18

0E728 **A** **0** / **A** **3** **2** **14** **2**



		0	1	2	3	4	5	6	7
REWINDING CLUTCH		NO	YES	NO	NO	YES	YES	NO	YES
PROTECTION CAP		NO	NO	YES	NO	YES	NO	YES	YES
BAYONET BRACKET		NO	NO	NO	YES	NO	YES	YES	YES

Customizing the cable reel: for example, if you are interested to the cable reel **0E728A0/A32142** but equipped with clutch and protection cap you will have to put number 4 instead of 0 so that the final code of the cable reel will be **0E728A4/A32142**



The version equipped with a clutch that allows rewinding the cable at a controlled rate, is characterized by the plate

“SPEED CONTROL”
TO BE REQUESTED WITH THE ORDER



P/N 0E728115

Protection cap, made of oil resistant rubber is useful against the accidental entry of water or foreign objects inside the cable reel.

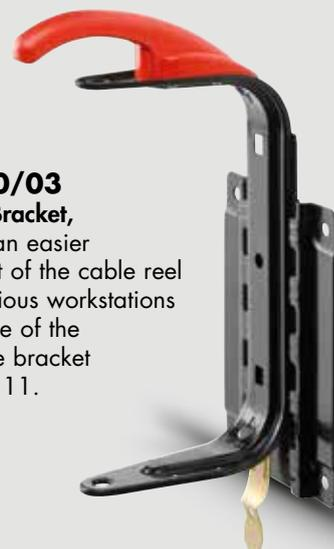

P/N 260/03

Bayonet Bracket, it allows an easier movement of the cable reel in the various workstations For the use of the adjustable bracket see page 11.

Cable reel Series 280 without transformer

with fluorescent portable lamp 11W S. F230-F12-F24

Colour:



Structure:

Shockproof plastic material

Stop:

Automatic through rack

Protection degree of electrical part:

IP44 without protection cap

IP45 with protection cap

Attention: The system is downgraded depending on the IP valve of the connected components.

Fixing bracket:

Fixed / adjustable

Usage environment

temperature:

-5°C / +40°C

EN 61242 CEI.EN.60598
2006/95/CE 2004/108/CE
2011/65/UE UE.874/2012



LED LIGHT = 3,6 W = 11 W = 50 W
600 LUMEN
6400 °K



CABLE REEL Series 280						LAMP Series F230 - F12 - F24				
Standard cable reel code	Number of conductors	Cable type	Cable length (m)	Cable inlet (m)	Inlet voltage	Lamp power supply voltage	Lamp connection	Max power W	Lamp protection degree	Light bulb supplied
OE728A0/C21145	2	2 x 1 - H05 RN-F	14 + 1	1,2	230 V AC-50 Hz	230 V AC-50 Hz	E27	11	IP65	P/N OE728001
OE728D0/C21145	2	2 x 1 - H05 RN-F	14 + 1	1,2	12 V DC	12 V DC	E27	11	IP65	P/N OE728002
OE728E0/C21145	2	2 x 1 - H05 RN-F	14 + 1	1,2	24 V DC	24 V DC	E27	11	IP65	P/N OE728003

⚠ The following codes are considered devoid of accessories: Rewinding clutch - Protection cap - Bayonet bracket.

⚠ All the models can be supplied with light bulbs belonging to energetic efficiency class B, A and A+ in accordance with European regulation UE.874/2012. Fluorescent light bulbs can be replaced only with same energetic efficiency class.



Light bulbs available

- P/N **OE728001** Light bulb 11W 230 V AC-50 Hz
- P/N **OE728002** Light bulb 11W 12 V DC
- P/N **OE728003** Light bulb 11W 24 V DC

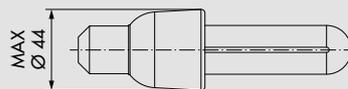

Feed the cable reel exclusively with the correct voltage of the lamp. Using it with different voltages irretrievably damages the lamp, and invalidate any warranty.

Overall dimensions (mm)

NORMAL

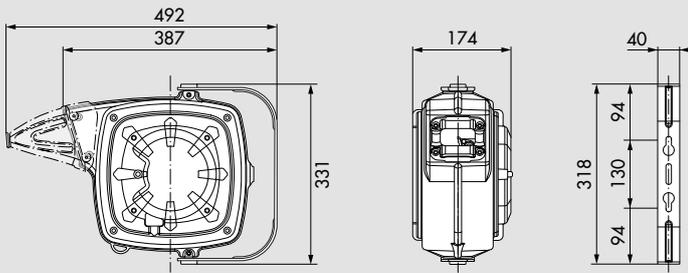

N°1 packing m³ 0,043 from kg 6,8 to 8,8



N°48 packages per pallet

WITH BRACKET

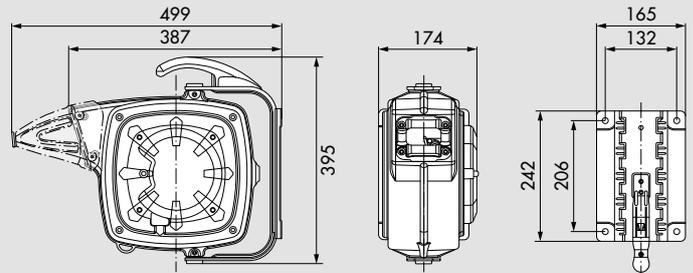

N°1 packing m³ 0,043 from kg 7,3 to 9,3



N°48 packages per pallet

How to customize the cable reel

All cable reel codes shown on the table on the opposite page are not provided with clutch, protection cover and bayonet bracket (see accessories description on page 11). To equip the cable reel with one or more of the above-mentioned accessories you need to modify the code as described in the table below.

⚠ All other technical characteristics are not subject to customization

Example of standard code as indicated in the table on page 20

0E728	A	0	/	C	2	1	14	5
--------------	----------	----------	---	----------	----------	----------	-----------	----------



		0	1	2	3	4	5	6	7
REWINDING CLUTCH		NO	YES	NO	NO	YES	YES	NO	YES
PROTECTION CAP		NO	NO	YES	NO	YES	NO	YES	YES
BAYONET BRACKET		NO	NO	NO	YES	NO	YES	YES	YES

Customizing the cable reel: for example, if you are interested to the cable reel **0E728A0/C21145** but equipped with clutch and protection cap you will have to put number 4 instead of 0 so that the final code of the cable reel will be **0E728A4/C21145**



The version equipped with a clutch that allows rewinding the cable at a controlled rate, is characterized by the plate

“SPEED CONTROL”
TO BE REQUESTED WITH THE ORDER



P/N 0E728115

Protection cap,

made of oil resistant rubber is useful against the accidental entry of water or foreign objects inside the cable reel.

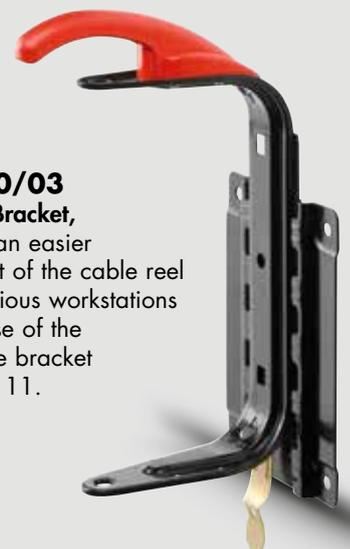

P/N 260/03

Bayonet Bracket,

it allows an easier movement of the cable reel in the various workstations For the use of the adjustable bracket see page 11.

Cable reel Series 280

without transformer from 12 V to 24 V AC/DC

with led portable lamp Series L1224

Colour:



Structure:

Shockproof plastic material

Stop:

Automatic through rack

Protection degree of electrical part:

IP44 without protection cap

IP45 with protection cap

Attention: The system is downgraded depending on the IP value of the connected components.

Fixing bracket:

Fixed / adjustable

Usage environment

temperature:

-5°C / +40°C



from 12 V to 24 V AC/DC

from 12 V to 24 V AC/DC

EN 61242 CEI.EN.60598
CEI.EN.62471

2006/95/CE 2004/108/CE
 2011/65/UE UE.874/2012



= = =

360 LUMEN
5000°K



CABLE REEL Series 280						LAMP Series L1224			
Standard cable reel code	Number of conductors	Cable type	Cable length (m)	Cable inlet (m)	Inlet voltage	Lamp power supply voltage	Led holder unit power W	Lamp protection degree	Led holder unit
OE728FO/C21144	2	2 x 1 - H05 RN-F	14 + 1	1,2	from 12 V to 24 V AC/DC	from 12 V to 24 V AC/DC	3,6	IP65	P/N OE728005

⚠ The following codes are considered devoid of accessories: Rewinding clutch - Protection cap - Bayonet bracket.

⚠ All the models can be supplied with light bulbs belonging to energetic efficiency class A, A+ and A++ in accordance with European regulation UE.874/2012.



Led holder unit

P/N OE728005 Kit led holder unit, with 12 leds each of 0,3W. Led holder unit cannot be replaced by others available in the market.



Feed the cable reel exclusively with the correct voltage of the lamp. Using it with different voltages irretrievably damages the lamp, and invalidate any warranty.

Overall dimensions (mm)

NORMAL

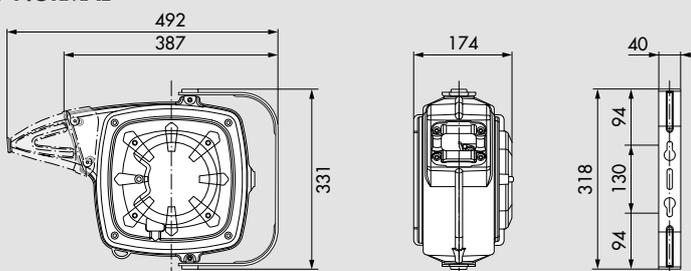

N°1 packing m³ 0,043 from kg 6,8 to 8,8



N°48 packages per pallet

WITH BRACKET

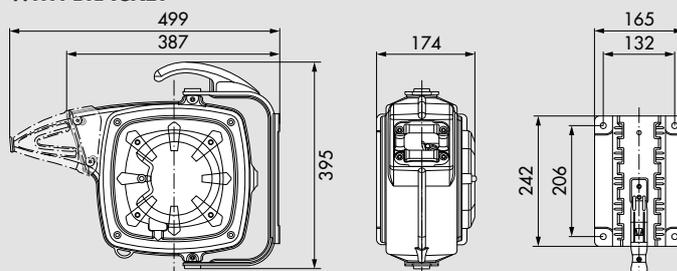

N°1 packing m³ 0,043 from kg 7,3 to 9,3



N°48 packages per pallet

How to customize the cable reel

All cable reel codes shown on the table on the opposite page are not provided with clutch, protection cover and bayonet bracket (see accessories description on page 11). To equip the cable reel with one or more of the above-mentioned accessories you need to modify the code as described in the table below.

⚠ All other technical characteristics are not subject to customization

Example of standard code as indicated in the table on page 22

OE728	A	0	/	C	2	1	14	5
--------------	----------	----------	---	----------	----------	----------	-----------	----------



		0	1	2	3	4	5	6	7
REWINDING CLUTCH		NO	YES	NO	NO	YES	YES	NO	YES
PROTECTION CAP		NO	NO	YES	NO	YES	NO	YES	YES
BAYONET BRACKET		NO	NO	NO	YES	NO	YES	YES	YES

Customizing the cable reel: for example, if you are interested to the cable reel **OE728F0/C21144** but equipped with clutch and protection cap you will have to put number 4 instead of 0 so that the final code of the cable reel will be **OE728F4/C21144**



The version equipped with a clutch that allows rewinding the cable at a controlled rate, is characterized by the plate

"SPEED CONTROL"

⚠ TO BE REQUESTED WITH THE ORDER



P/N OE728115

Protection cap,

made of oil resistant rubber is useful against the accidental entry of water or foreign objects inside the cable reel.

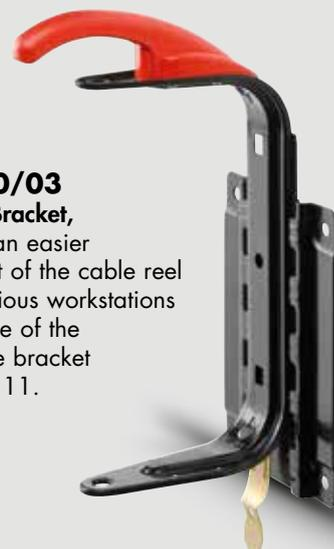

P/N 260/03

Bayonet Bracket,

it allows an easier movement of the cable reel in the various workstations For the use of the adjustable bracket see page 11.

Cable reel Series 290 with transformer 230 V with led portable lamp Series L1224

Colour:



Structure:

Shockproof plastic material

Stop:

Automatic through rack

Protection degree of electrical part:

IP44 without protection cap

IP45 with protection cap

Attention: The system is downgraded depending on the IP valve of the connected components.

Fixing bracket:

Fixed / adjustable

Usage environment

temperature:

-5°C / +40°C

EN 61242 CEI.EN.60598
CEI.EN.62471

2006/95/CE 2004/108/CE
2011/65/UE UE.874/2012



LED LIGHT

3,6 W = 11 W = 50 W

360 LUMEN
5000°K



24 V AC
50 Hz

from 12 V to 24 V AC/DC

230 V AC-50 Hz

CABLE REEL Series 280						LAMP Series L1224			
Standard cable reel code	Number of conductors	Cable type	Cable length (m)	Cable inlet (m)	Inlet voltage	Lamp power supply voltage	Led holder unit power W	Lamp protection degree	Led holder unit
OE729A0/C21144	2	2 x 1 - H05 RN-F	14 + 1	1,2	230 V AC-50 Hz	from 12V to 24 V AC/DC	3,6	IP65	P/N OE728005

⚠ The following codes are considered devoid of accessories: Rewinding clutch - Protection cap - Bayonet bracket.

⚠ All the models can be supplied with light bulbs belonging to energetic efficiency class A, A+ and A++ in accordance with European regulation UE.874/2012.



Led holder unit

P/N OE728005 Kit led holder unit, with 12 leds each of 0,3W. Led holder unit cannot be replaced by others available in the market.

Feed the cable reel exclusively with the correct voltage of the lamp. Using it with different voltages irretrievably damages the lamp, and invalidate any warranty.

Overall dimensions (mm)

▶ NORMAL

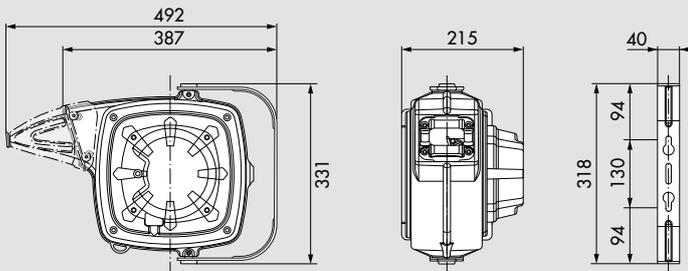

📦 N°1 packing m³ 0,054 📦 from kg 7,0 to 9,0



N°40 packages per pallet

▶ WITH BRACKET

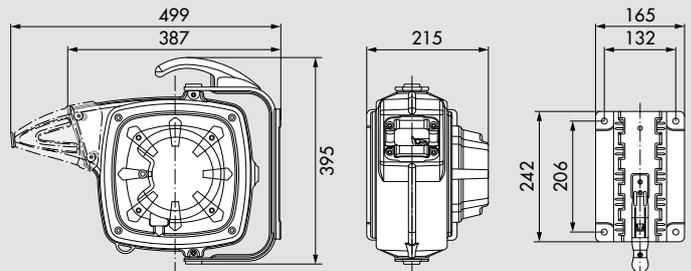

📦 N°1 packing m³ 0,054 📦 from kg 8,0 to 10,0



N°40 packages per pallet

How to customize the cable reel

All cable reel codes shown on the table on the opposite page are not provided with clutch, protection cover and bayonet bracket (see accessories description on page 11). To equip the cable reel with one or more of the above-mentioned accessories you need to modify the code as described in the table below.

⚠️ All other technical characteristics are not subject to customization

Example of standard code as indicated in the table on page 24

0E729 **A** **0** / **C** **2** **1** **14** **4**

↑
Accessories

		0	1	2	3	4	5	6	7
REWINDING CLUTCH		NO	YES	NO	NO	YES	YES	NO	YES
PROTECTION CAP		NO	NO	YES	NO	YES	NO	YES	YES
BAYONET BRACKET		NO	NO	NO	YES	NO	YES	YES	YES

Customizing the cable reel: for example, if you are interested to the cable reel **0E729A0/C21144** but equipped with clutch and protection cap you will have to put number 4 instead of 0 so that the final code of the cable reel will be **0E729A4/C21144**



The version equipped with a clutch that allows rewinding the cable at a controlled rate, is characterized by the plate

"SPEED CONTROL"

⚠️ **TO BE REQUESTED WITH THE ORDER**



P/N 0E728115

Protection cap,

made of oil resistant rubber is useful against the accidental entry of water or foreign objects inside the cable reel.

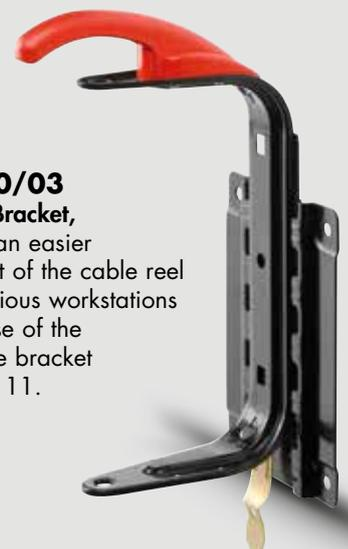

P/N 260/03

Bayonet Bracket,

it allows an easier movement of the cable reel in the various workstations For the use of the adjustable bracket see page 11.

LAMPS

Fluorescent lamp
Series F230 - F12 - F24



Led lamp
Series L1224



ECODORA, portable lamps are strong and ideal for use in many fields of application. The adjustable hook and magnetic support allow their correct positioning in any situation. Depending on the model, they emit yellow or white light without generating heat and guarantee a large area of uniform illumination that ensures a large visual field.

ADVANTAGES

- ▶ Longer service life than a classic incandescent light bulb.
- ▶ Increased light output.
- ▶ Emits light at 5000° K, comparable with the sun light (led version).
- ▶ Light diffusor to make uniform the led's beam.
- ▶ Lower heating.
- ▶ Lower energy consumption.
- ▶ Easy positioning thanks to the swivelling hook and the magnetic support.
- ▶ Switch protected from accidental actuation.
- ▶ Bicomponent non-slip handgrip.



The model with fluorescent lamp is supplied with light bulb.

Fluorescent portable lamp that fits only energy saving light bulbs E27 max 11W.

LAMPS

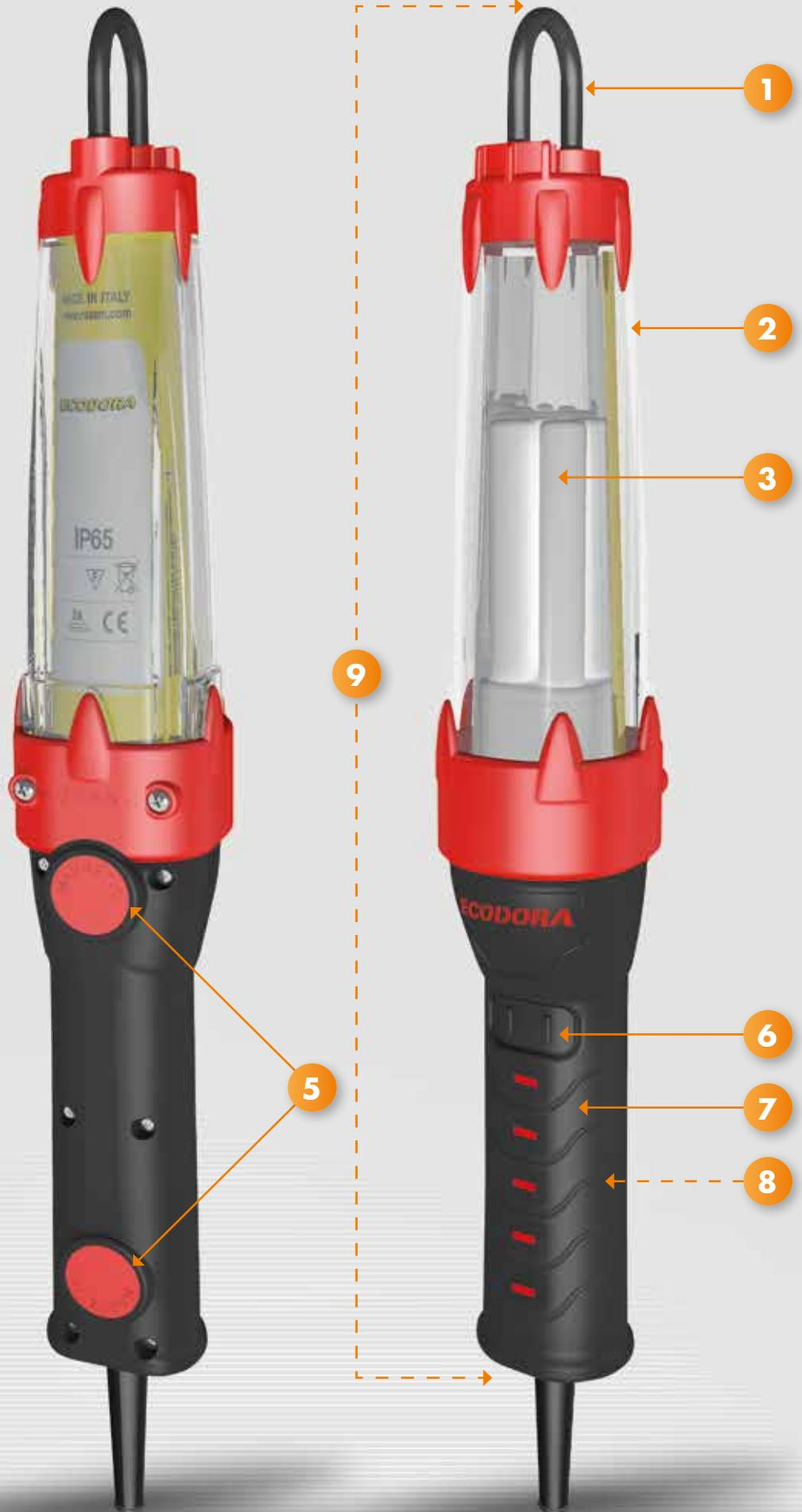

Technical characteristics



1 ADJUSTABLE HOOK
360° rotating, with locking loop device, allows to securely hook the lamp to various types of supports. The innovative closed loop system ensures a safe hooking also on moving equipment.

2 TRANSPARENT PROTECTION COVER
In high resistance polymer, it protects the lamp from accidental shocks and against entry of dust, dirt and liquids. Replaceable screen.

3 FLUORESCENT LIGHT BULB 11W
For voltages from 12 V DC - 24 V DC - 230 V AC-50 Hz. Series F280 - F12 - F24

4 LED HOLDER UNIT
For voltages from 12 V AC/DC a 24 V AC/DC. It includes 12 white LEDs (5000 °K) for a total of 3,6 W. Easily replaceable. Series L1224.

5 MAGNETIC SUPPORT
Integrated in the handgrip, allows the adhesion of the lamp to any surface. This simple and practical device is useful when there are no holds for the hook of the lamp.

6 PROTECTED SWITCH
Incorporated inside the handle grip, it is protected from accidental shocks and against entry of dust, dirt and liquids.

7 HANDGRIP
In anti-skidding bicomponent, it allows a rapid and safe grip of the lamp.

8 PROTECTION FUSE
2 A, electrically protects the lamp from eventual short circuits. In the fluorescent lamp version is user replaceable.

9 PROTECTION DEGREE
IP 65.



Portable lamp Series F230 - F12 - F24 supplied with fluorescent bulb of: 12 V DC - 24 V DC - 230 V AC

Technical characteristics:

- Swivelling hook
- Magnetic support
- Transparent replaceable protection cover
- Fluorescent light bulb 11W
- Protection degree IP65
- Anti-skidding grip
- Protected switch



F230

EN 60598-1 EN 60598-2-8

2006/95/CE 2004/108/CE
2011/65/UE UE874/2012

F12 - F24

EN 60598-1 EN 60598-2-8

2006/95/CE 2004/108/CE
2011/65/UE UE874/2012



SWIVELLING HOOK



PROTECTED SWITCH



LED LIGHT

3,6 W = 11 W = 50 W
600 LUMEN
6400 °K

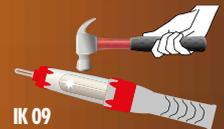

FLUORESCENT PORTABLE LAMP Series F230-F12-F24					
Fluorescent lamp code	Power supply voltage	Light bulb coupling	Max power W	Lamp protection degree	Light bulb supplied
OE7F1/2301	230 V AC-50 Hz	E27	11	IP65	P/N OE728001
OE7F1/1201	12 V DC	E27	11	IP65	P/N OE728002
OE7F1/2401	24 V DC	E27	11	IP65	P/N OE728003

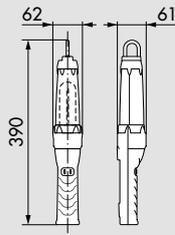

N°1 packing m³ 0,0057
kg 0,35

- ⚠ The above-mentioned codes refer to the lamp supplied without cable.
- ⚠ All the models can be supplied with light bulbs belonging to energetic efficiency class B, A and A+ in accordance with European regulation UE.874/2012. Fluorescent light bulbs can be replaced only with same energetic efficiency class.



Light bulbs available

- P/N OE728001 Light bulb 11W 230 V AC-50 Hz
- P/N OE728002 Light bulb 11W 12 V DC
- P/N OE728003 Light bulb 11W 24 V DC



Feed the lamp exclusively with the correct voltage.
 Using it with different voltages irretrievably damages the lamp, and invalidate any warranty.

Portable lamp Series L1224 supplied with led holder unit: from 12 V to 24 V AC/DC

Technical characteristics:

- Swivelling hook
- Magnetic support
- Transparent replaceable protection cover
- (12 leds) led holder unit
- Protection degree IP65
- Anti-skidding grip
- Protected switch

F230

CE		
EN 60598-1 EN.60598-2-8 CEI.EN.62471		
2006/95/CE 2004/108/CE 2011/65/UE UE874/2012		



SWIVELLING HOOK



PROTECTED SWITCH



LED LIGHT
3,6 W



11 W
50 W

360 LUMEN
5000 °K



IP 65

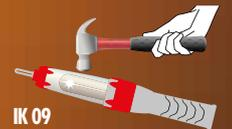

IK 09

LED PORTABLE LAMP Series L1224					
Led lamp code	Power supply voltage	N° of leds	Led holder unit power W	Lamp protection degree	Led holder unit
OE7L1/1301	12/24 V AC/DC	12	3,6	IP65	P/N OE728005

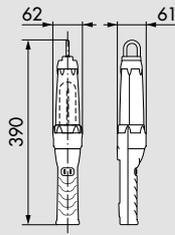

N°1 packing m³ 0,0057
kg 0,35

All the models can be supplied with light bulbs belonging to energetic efficiency class A, A+ and A++ in accordance with European regulation UE.874/2012.



Led holder unit

P/N OE728005 Kit led holder unit, with 12 leds each of 0,3W. Led holder unit cannot be replaced by others available in the market.

Feed the lamp exclusively with the correct voltage. Using it with different voltages irretrievably damages the lamp, and invalidate any warranty.

EARTHING CABLE REEL



Presentation

The cable reel easily meets the need to ground the tanks containing flammable liquids during the operations of transfer in order to avoid the accumulation of dangerous electrostatic charges.

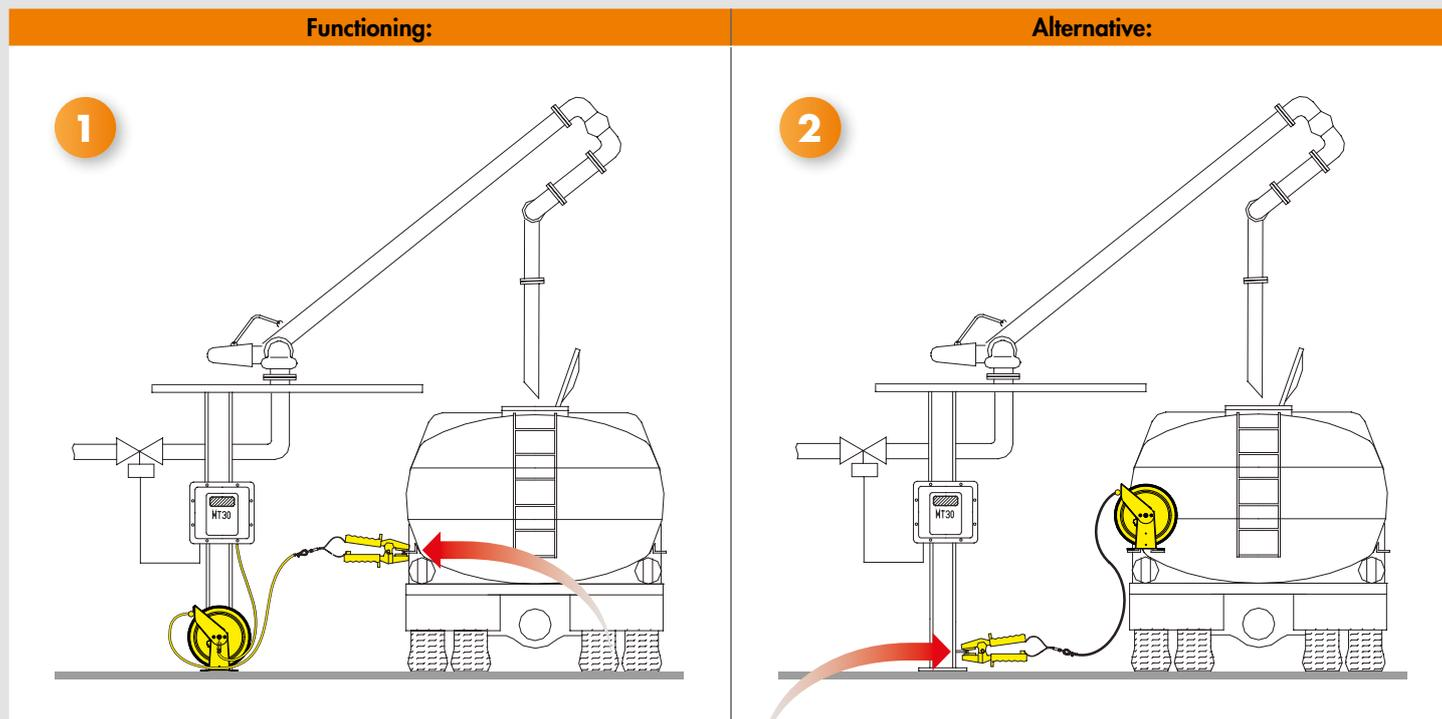

The assigned operator, before performing the transfer of the fluids, must connect the clamp on the end of the cable to the proper connecting plate obligatorily foreseen on all portable tanks (fig. 1).

The cable reel can be installed on the mobile tank and the pliers connected to the appropriate ground plate (fig. 2).

Atex directive

The cable reel Series 350 is marked according to Atex directive, category 3 (zone 2).

The anti-deflagration pliers, standard on some models, can be placed instead in a potentially explosive area (zone 1) as indicated in the relative marking.

APPLICATION FIELDS

Deposits and refineries, aviation, tank trucks, naval



earthing

Colour:



Structure:

Shockproof plastic material

Stop:

Automatic through rack

Protection degree of electrical part:

IP44 without protection cap

IP45 with protection cap

Attention: The system is downgraded depending on the IP value of the connected components.

Fixing bracket:

Fixed / adjustable

Usage environment temperature:

-5°C / +40°C



earthing pliers
100A P/N **OE735111**



earthing pliers
50A P/N **OE735112**



10A ANTI-DEFLAGRATION
earthing pliers



CE

EN 61242

2006/95/CE 2004/108/CE
2011/65/UE

EARTHING CABLE REEL S. 280

Standard cable reel code	Number of conductors	Cable type	Cable (m) length	Cable (m) inlet	Connection flow in A	Earthing pliers
OE728CO/E16151	1	1 x 6 - H05 V-F	15 + 1	1,2	50A	without
OE728CO/E17101	1	1 x 16 - H05 V-F	10 + 1	1,2	100A	without
OE728CO/E16157	1	1 x 6 - H05 V-F	15 + 1	1,2	50A	
OE728CO/E17108	1	1 x 16 - H05 V-F	10 + 1	1,2	100A	
OE728CO/G16146	1	1 x 6 - PUR	14,5	1,2	10A	

Overall dimensions (mm)

NORMAL

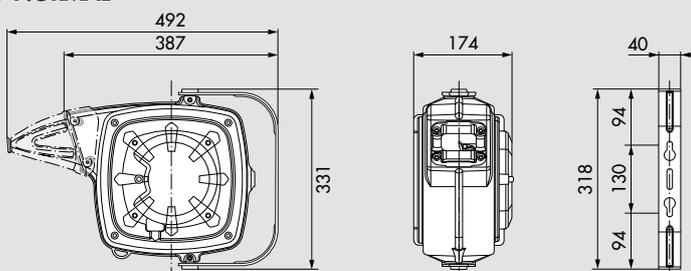

N°1 packing m³ 0,043 from kg 6,4 to 8,2



N°48 packages per pallet

WITH BRACKET

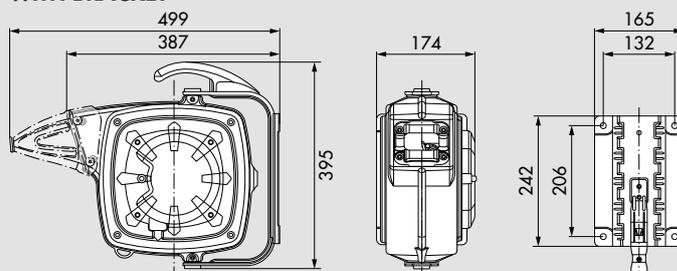

N°1 packing m³ 0,043 from kg 7,0 to 8,8



N°48 packages per pallet

How to customize the cable reel

All cable reel codes shown on the table on the opposite page are not provided with clutch, protection cover and bayonet bracket (see accessories description on page 11). To equip the cable reel with one or more of the above-mentioned accessories you need to modify the code as described in the table below.

⚠ All other technical characteristics are not subject to customization

Example of standard code as indicated in the table on page 34

OE728 **C** **0** / **E** **1** **6** **15** **1**



		0	1	2	3	4	5	6	7
REWINDING CLUTCH		NO	YES	NO	NO	YES	YES	NO	YES
PROTECTION CAP		NO	NO	YES	NO	YES	NO	YES	YES
BAYONET BRACKET		NO	NO	NO	YES	NO	YES	YES	YES

Customizing the cable reel: for example, if you are interested to the cable reel **OE728C0/E16151** but equipped with clutch and protection cap you will have to put number 4 instead of 0 so that the final code of the cable reel will be **OE728C4/E16151**



The version equipped with a clutch that allows rewinding the cable at a controlled rate, is characterized by the plate

"SPEED CONTROL"

⚠ TO BE REQUESTED WITH THE ORDER



P/N OE728115

Protection cap,

made of oil resistant rubber is useful against the accidental entry of water or foreign objects inside the cable reel.

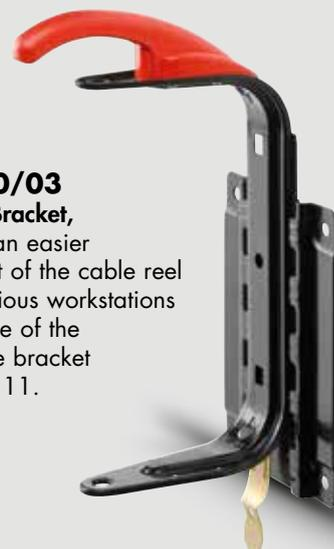

P/N 260/03

Bayonet Bracket,

it allows an easier movement of the cable reel in the various workstations For the use of the adjustable bracket see page 11.

earthing

Colour:



Structure:

Painted steel

Stop:

Automatic through rack

Fixing bracket:

Fixed

Usage environment

temperature:

-5°C / +40°C



earthing pliers
100A P/N **OE735111**



earthing pliers
50A P/N **OE735112**



10A ANTI-DEFLAGRATION
earthing pliers



EARTHING CABLE REEL Series 350

Standard cable reel code	Number of conductors	Cable type	Conducting cable material	Conducting cable insulation	Cable (m) length	Earthing pliers
OE735000	1	without cable	max cable capacity 30 m - cross section 16 mm ²			without
OE735131/60141	1	1 x 6	Copper	PUR	14,5	anti-deflagration 10A
OE735131/60261	1	1 x 6	Copper	PUR	26	anti-deflagration 10A
OE735131/60152	1	1 x 6	Copper	PUR	15	standard 50A
OE735131/60252	1	1 x 6	Copper	PUR	25	standard 50A
OE735141/60152	1	1 x 7	Steel	PVC	15	standard 50A
OE735141/60252	1	1 x 7	Steel	PVC	25	standard 50A

Technical characteristics

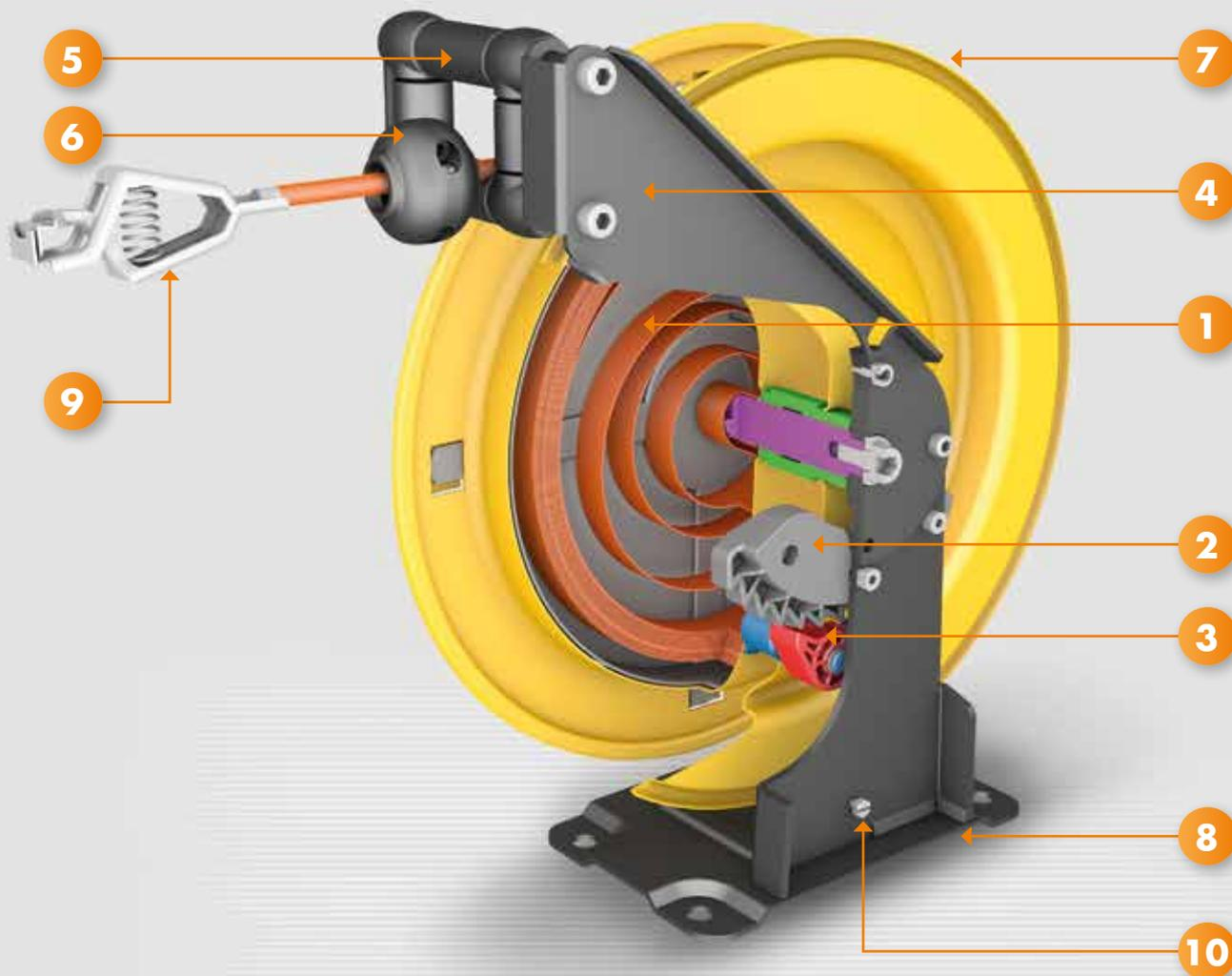

- | | | |
|---|---|---|
| <p>1 REWINDING SPRING
With constant force fully closed and protected.</p> | <p>4 MULTI POSITION ARMS
To facilitate the release of the cable according to the installation of the cable reel.</p> | <p>7 CABLE REEL DRUM
Sturdy and practical with ribs and rounded edges.</p> |
| <p>2 STOP RACK
Allows the blocking of the cable to the wanted measure.</p> | <p>5 SELF-LUBRICATING CABLE GUIDE ROLLERS
Wide omnidirectional nozzle.</p> | <p>8 HOOKING BRACKET
It is provided with four slotted holes that allow easy and safe installation.</p> |
| <p>3 PAWL
Of increased thickness with reinforcement ribs to ensure high resistance to stresses. Actuated by a spring in stainless steel.</p> | <p>6 CABLE CLAMP PAD
Adjustable.</p> | <p>9 EARTHING PLIERS
To eliminate the accumulation of electrostatic energy.</p> <p>10 EARTHING CONNECTION</p> |

Overall dimensions (mm)

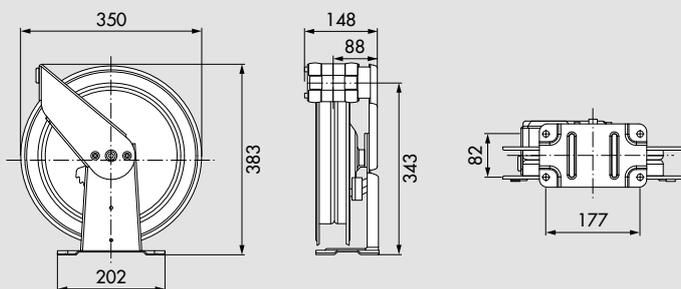

N°1 packing m^3 0,036 from kg 10,3 to 11,5



N°36 packages per pallet

HOSE REEL Air-Water 20 bar 40 °C

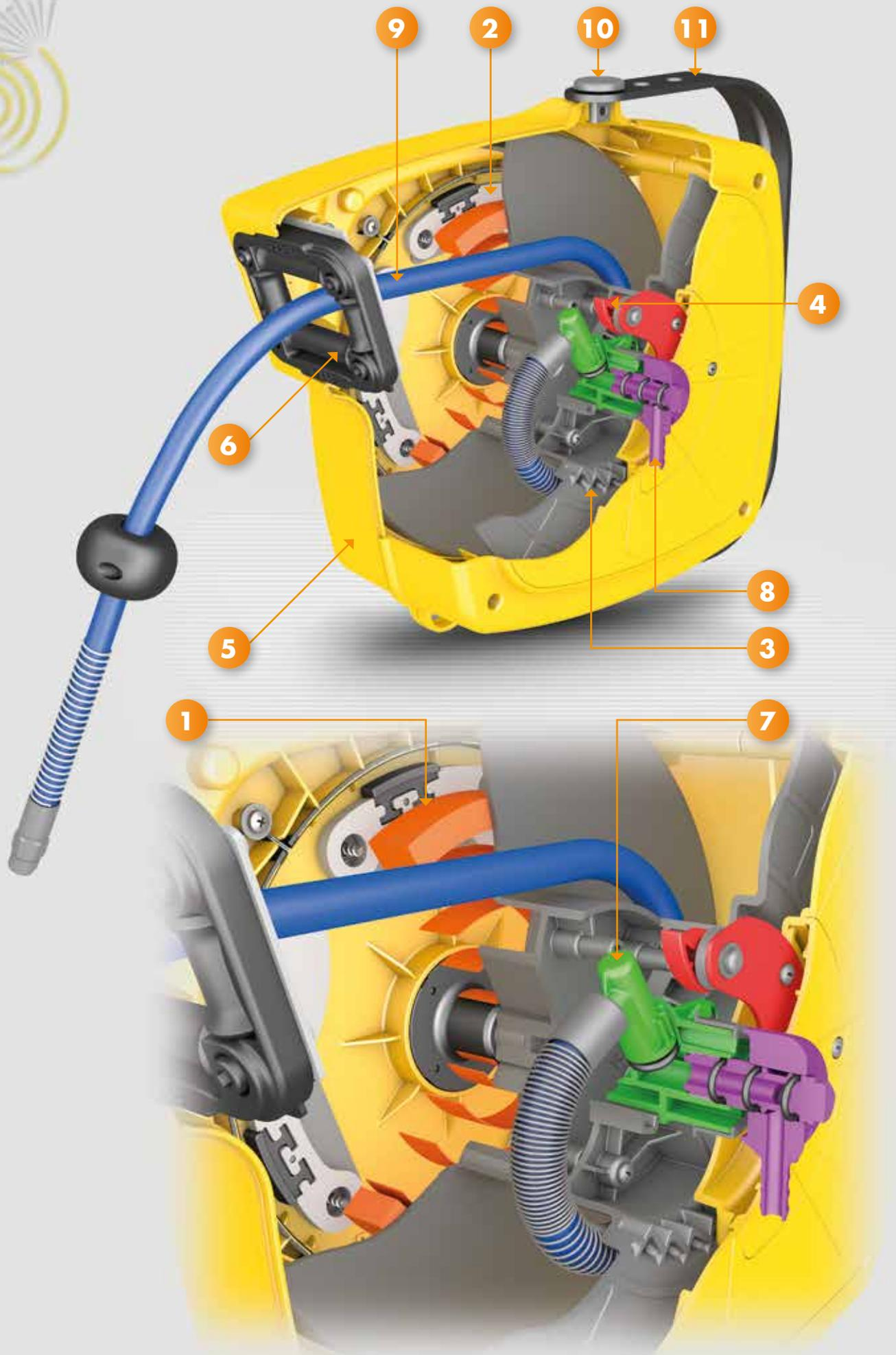

Technical characteristics

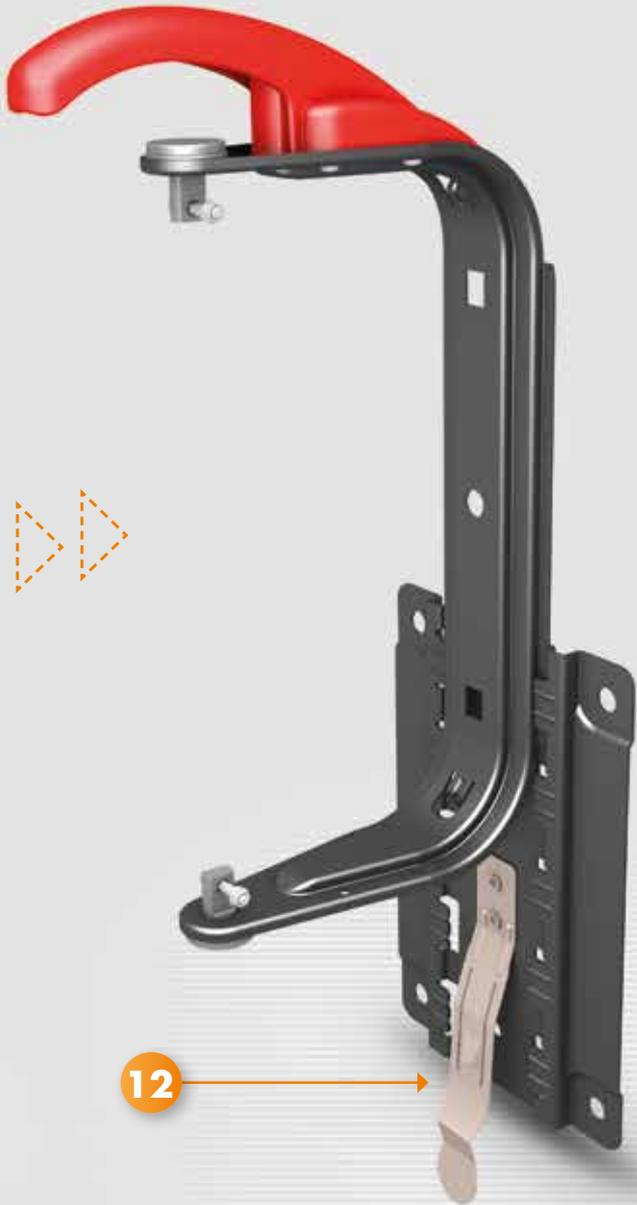

1 SPRING

Rewinding spring totally protected from the external environment. The spring is subjected to a durability test of 20000 cycles (each cycle corresponds to the complete unwinding and rewinding of the hose thus simulating an average life of over 10 years. Possibility to intervene to adjust the spring force increasing or decreasing the preload.

2 REWINDING CLUTCH

Optional, devoid of complex and potentially wearing kinematic motions, allows the rewinding of the drum at a safe speed.

3 STOPPING RACK

It has an increased width and reinforcement ribs ensuring greater durability and sturdiness.

4 PAWL

Of increased thickness with reinforcing ribs ensuring high stress resistance and durability.

5 STRUCTURE

Strong and compact made of highly resistant shockproof material mechanical, designed to withstand over time.

6 HOSE GUIDE WITH ROLLERS

Sturdy and resistant with reinforced steel interior. Wide width which allows to guide properly the hose for correct rewind. Equipped with 4 rollers, 2 arranged horizontally (above and below) and 2 arranged vertically (left and right) that reduce hose wear.

7 FITTINGS AND CENTRAL PIN

Built in suitable material to withstand harsh products (Delrin®) and with passages dimensioned so as to avoid flow resistance.

8 ENTRY ARTICULATION

With internal passage properly sized to the used pipes. The 90° fitting can be oriented in eight different positions, 45° equitably spaced to facilitate the connection of the inlet hose (supplied).

9 HOSE

Polyurethane hose with hose stop pad and outlet articulation that ease the use of the pneumatic equipment (inflating guns, screwers, etc.) to which it is connected. Two metal coils positioned at either end of the hose are a safe reinforcement to its structure.

10 SIDE CLUTCH

The bracket is equipped with a special clutch that controls the rotational speed on the right and on the left of the hose reel.

11 ADJUSTABLE BRACKET

Adjustable up to 90° per side, of a sturdy structure with loop fixing holes that facilitate wall mounting.

12 BAYONET BRACKET

The bracket with bayonet type quick coupling is available on request and it allows an easier movement of the hose reel in the various workstations.

Colour:



Structure:

Shockproof plastic material

Stop:

Automatic through rack

Fixing bracket:

Fixed / adjustable

Usage environment

temperature:

-5°C / +40°C



some examples of use

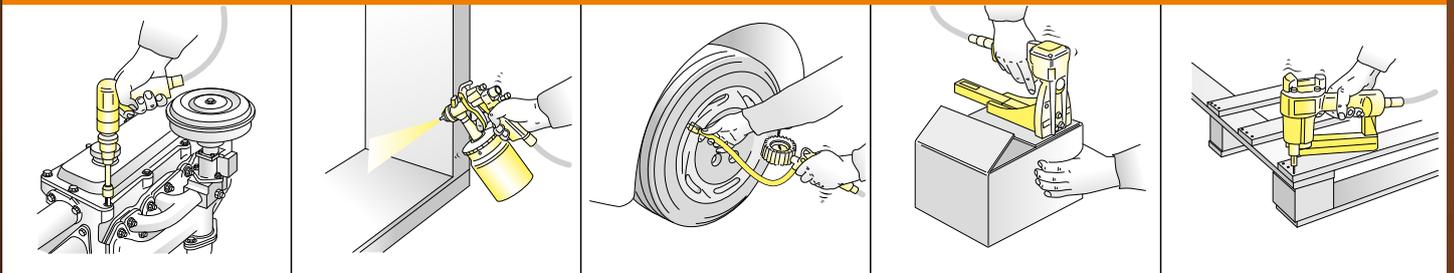

HOSE REEL Series 280

Standard hose reel code	Hose length and ø	Coupling	
		inlet	outlet
42808/11	10 m - 8x12 (911/10)	M 3/8"G	M 1/4"G
42808/12	14 m - 8x12 (911/14)	M 3/8"G	M 1/4"G
42808/15	8 + 1 m - 10x14,5 (921/9)	M 3/8"G	M 3/8"G

EQUIPPED WITH:

- swivel joint pipe outbound
- polyurethane hose (blue) with protection spring on fittings
- galvanized steel fittings
- brass joint
- seals in "viton"
- length in entrance 1,5 m



OUTPUT HOSE DETAIL

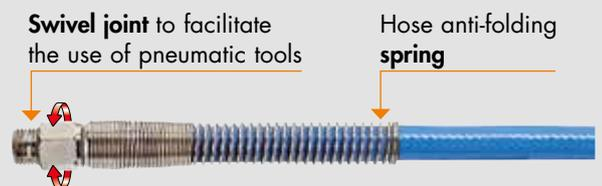

Overall dimensions (mm)

▶ NORMAL

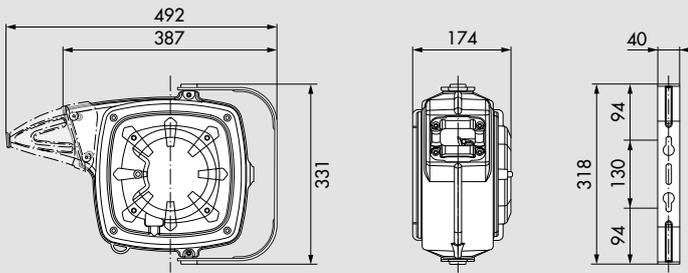

📦 N°1 packing m³ 0,043 📦 from kg 6,0 to 7,9



N°48 packages per pallet

▶ WITH BRACKET

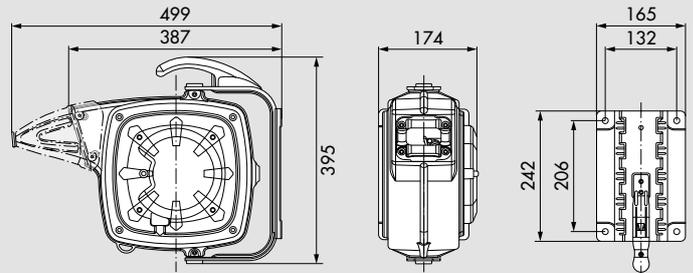

📦 N°1 packing m³ 0,043 📦 from kg 6,0 to 7,9



N°48 packages per pallet

How to customize the hose reel

All hose reel codes shown on the table on the opposite page are not provided with clutch, protection cover and bayonet bracket (see accessories description on page 11). To equip the cable reel with one or more of the above-mentioned accessories you need to modify the code as described in the table below.

⚠️ All other technical characteristics are not subject to customization

Example of standard code as indicated in the table on page 40

428 **0** **8** / **1** **1**

↑
Accessories

		0	1	4	5
REWINDING CLUTCH		NO	NO	YES	YES
BAYONET BRACKET		NO	YES	NO	YES

Customizing the cable reel: for example, if you are interested to the cable reel **42808/11** but equipped with clutch you will have to put number 4 instead of 0 so that the final code of the cable reel will be **42848/11**



The version equipped with a clutch that allows rewinding the cable at a controlled rate, is characterized by the plate

“SPEED CONTROL”
⚠️ **TO BE REQUESTED WITH THE ORDER**

P/N 260/03
Bayonet Bracket,
it allows an easier hose movement of the reel in the various workstations
For the use of the adjustable bracket see page 11.

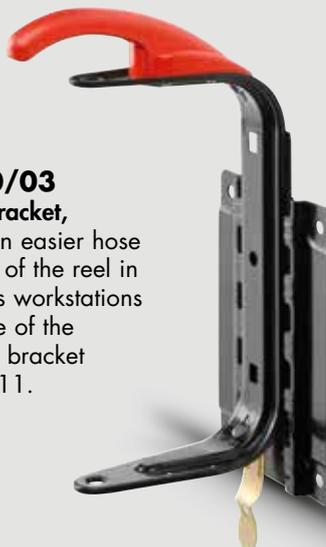

P/N 260/01
Wall bracket,
to buy separately
in case you want to create multiple points for fitting the hose reel provided with bayonet bracket.



General sales conditions

For foreign markets

The following general sales conditions regulate the sale of goods and services by the company ECODORA S.r.l. for customers residing outside the territory of the Italian State.

Art. 1 GOODS DELIVERY TERMS

The goods are delivered ex works ECODORA S.r.l..

The subsequent transport/shipment must occur by, in the name and at the expense of the purchasing customer, even by means of carrier designated by the same. All risks arising from loading, subsequent custody and transport are borne entirely by the purchasing customer.

Art. 2 MINIMUM ORDERS

Each order cannot be for less than €. 1,500.00, net of taxes, discounts and rebates. If, at the option of ECODORA S.r.l., orders for lower amounts are accepted, an extra charge of €. 155.00 shall be applied for order management administrative expenses.

Art. 3 ACCESSORIES

All the accessories given in the price list (rubber protection, clutch, swivelling bracket) are supplied exclusively for fitting to or combining with the items ECODORA S.r.l. produces.

Art. 4 COMPLAINTS

Any defects immediately noticed after a brief inspection of the goods (damage, shortages or different product from that ordered) must be notified in writing to our company within 8 (eight) days of receipt the goods.

Any defects in the product noticeable only during its use must be notified in writing to ECODORA S.r.l. within 8 (eight) days of being detected.

Any returns of goods must be authorized in advance by ECODORA S.r.l. and freight charges are at the customer's expenses.

Art. 5 DELIVERY TIMES/TERMS

Delivery times and dates are only approximate and are subject to change.

Any delays in delivery do not entitle the customer to cancel the order or claim compensation for damages caused by delay of delivery.

Delivery times for urgent orders must be agreed directly by ECODORA S.r.l..

ECODORA S.r.l. has the right not to carry out the order and/or totally or partially carry it out, without this giving rise to reimbursement or claims for compensation for damage.

Art. 6 PACKS AND PACKAGING

Packaging costs are included in the price, except for special packing, which shall be charged at cost.

Art. 7 PRICES

The current Price list cancels and replaces the previous price list. In the event of changes to our price list and/or individual items, the goods shall be forwarded at the price in force on the day of delivery. The price list and/or the prices of individual items can be changed even without notice, according to the changes in market conditions or technical innovations/modifications made to the product. The prices are understood to be ex works ECODORA S.r.l..

Art. 8 PAYMENTS

Payments must be made exclusively to ECODORA S.r.l. at the agreed conditions. Under no circumstances will deductions or roundings be accepted.

In case of late payment with respect to the agreed conditions, ECODORA S.r.l. reserves the right to charge interest at the current rate, effective from the day after that agreed for payment, plus any additional expenses. Discounts conditional on the payment term and already credited shall be recharged.

Art. 9 WARRANTY

ECODORA S.r.l. provides each product with the communication of particular instructions for the installation, use and maintenance requirements and the need to carry out possible checks on the product. Incorrect installation, use or maintenance of the product shall void the warranty. The articles must be returned free to our Factory for checking and acceptance. All the technical information and data mentioned in the catalogue and in the price-list in force are not binding and can be changed without prior notice for the purpose of improving the quality of the products.

All products in the present price list are manufactured by ECODORA S.r.l. and are guaranteed for a period of 1 (one) year.

Art. 10 RESPONSIBILITY

ECODORA S.r.l. is exempt from any responsibility and liability for accidents that may occur to persons and property, as a result of or during the use of the equipment, due to or depending on the same whenever the products have been damaged during transport, tampered with or modified, or improperly used, or stored, installed, protected and preserved without complying with the instructions of ECODORA S.r.l. as given in the installation, use and maintenance instruction manuals for each product.

ECODORA S.r.l. is liable for the value for the supplied product and cannot be held responsible in any way for other possible costs or additional costs that the customer may bear.

Art. 11 COMPETENT LAW COURT

Any disputes shall be settled by the Law Court of Vicenza, Italy.





The Intellectual Property rights to the trademark ECODORA are exclusive and all rights to its use and reproduction are reserved.

The ECODORA trademark is a protected trademark at an international level. No part of the ECODORA trademark and its logo may be utilized, copied and/or used in any form, time and space, even by means of improper alterations.

The Intellectual Property rights on the images published in this catalogue are owned exclusively by ECODORA S.r.l. and any unauthorized reproduction is prohibited.

Any use in general of the assets protected by the Intellectual Property rights of the trademark ECODORA is prohibited and is subject to the prior written permission of ECODORA S.r.l..

The manufacturer declines any responsibility for possible inaccuracies contained in this catalogue, due to printing or transcription errors.

The manufacturer reserves the right to make any changes or improvements of a functional, technical or aesthetic nature without prior notice.

The publication and the reprint of this price list is forbidden.



All rights reserved to Ecodora s.r.l.

Ecodora S.r.l.
Vicenza - Italy
tel. +39 0424 570891
fax +39 0424 571354
www.ecodora.com
info@ecodora.com



WECAVV2015-GB

CE Made in Italy