

FA 016 · FAPC 016

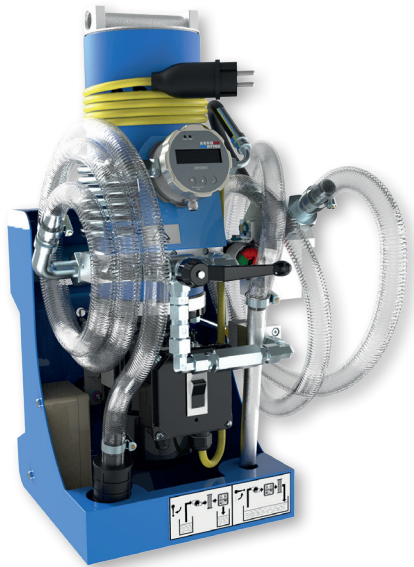

Oil Service Unit FAPC 016



Integrated OPCOM Particle Monitor

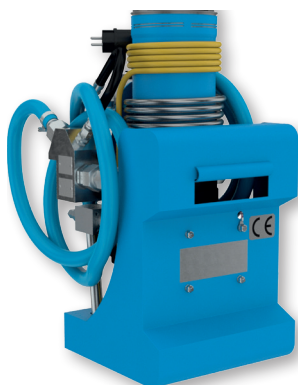

Rear view Oil Service Unit FAPC 016

- › Easy filling and cleaning
- › Compact design, comfortable handling
- › High filtration efficiency
- › Option: with oil cleanliness monitor and data storage

Description

FA 016

With the FA 016, hydraulic and lubricating systems can be easily filled or cleaned with off-line filtration.

Compact design and comfortable handling

The compact design allows easy access to the oil tank. The FA 016 comes ready to connect with hose packages. The ultra-fine elements can quickly be changed without special auxiliary tools. The suction hose and the pressure hose can be wound around the hose fixtures. Residual oil from the hoses is collected in the oil pan.

Protection of components through ultra-fine filtration

The EXAPOR[®]MAX 2 ultra-fine elements are the heart of the ARGO-HYTOS Cleanline portable systems. High separation efficiencies guarantee excellent cleanliness levels and thereby highest protection of components. The high dirt holding capacity of the EXAPOR[®]MAX 2 ultra-fine elements allows economic operation of the Cleanline portable.

FA 016 with OPCOM Particle Monitor – FAPC 016

2 in 1: FA 016 with Oil Cleanliness Monitor OPCOM
The FA 016 can be equipped with an oil cleanliness monitor. The ARGO-HYTOS OPCOM Particle Monitor permanently monitors the current cleanliness class during the cleaning or filling process.

When monitoring the cleanliness class, a ball valve is used to select "behind filter" (e.g. when filling systems) or "before filter" (e.g. when cleaning filled oil). At the display of the OPCOM Particle Monitor, the ordinal numbers of the particle sizes 4, 6, 14 and 21 µm are shown according to ISO 4406:1999.

The FAPC 016 can store up to 3000 data sets. A PC-software for data recording and representation of the measured values can be downloaded for free at www.argo-hytos.com. The data can be transmitted to a computer via an RS232 interface so that the development can be visualized and followed graphically or in table form.

Easy Transport

For easy transportation of the FA 016 and FAPC 016, an optional trolley can be hooked onto the standing unit. Trouble-free transport over long distances is also possible.

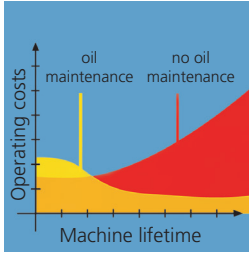

Economical

The FA 016 · FAPC 016 Oil Service Unit offers protection that can extend the lifetime of machinery. This protection gives a direct return on investment through extended service intervals and increased machine availability.



Portable in any position

Thanks to the compact design, the FA 016 · FAPC 016 can be easily carried and also be used in inaccessible areas of hydraulic systems. Hoses and electric cables can be fixed at the service unit. The Cleanline portable can be operated and transported in both upright and horizontal positions.



User-friendly filter element change

The filter element can be removed from the housing together with the cover. The dirt retention valve ensures that solid particle sediment is completely removed with the filter element.

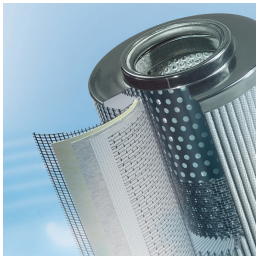

Quality in detail

The EXAPOR®MAX 2 ultra-fine element is the heart of the FA 016 · FAPC 016. A high separation efficiency and dirt holding capacity guarantee maximum cleanliness levels and service intervals in line with practical needs.



Controlled cleaning with Oil Cleanliness Monitor OPCOM

The FA 016 · FAPC 016 can optionally be equipped with the ARGO-HYTOS Oil Cleanliness Monitor OPCOM which allows to monitor the oil cleanliness during the cleaning or filling process. The current cleanliness classes are indicated on the display or can be queried via the provided RS232-interface.

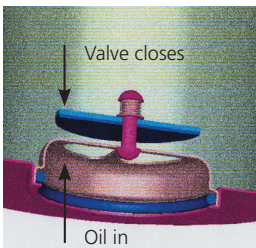

Maintenance-free filter housing thanks to a unique filter element technique

Fluid flows through the element from the inside to the outside. The built-in dirt retention valve closes automatically when the element is removed, ensuring that all dirt is removed from the housing together with the element.

Characteristics

Hydraulic connection

Hoses:

Suction hose NG 20, length 1.8 m / 5.9 ft, with suction strainer 300 µm, Ø approx. 49 mm / 1.9 inch pressure hose NG 20, length 2 m / 6.6 ft, pressure or supply lance Ø approx. 20 mm / 0.8 inch (extensions on request)

Electrical connection / electric motor

Electric motor, air cooled fan type

Cable: length 2.5 m / 8.2 ft
 Electro motor types: 1~ 110 V / 60 Hz
 1~ 230 V / 50 or 60 Hz
 Protection type: IP 55

Tank volume

Approx. 2.4 l / 0.6 gal

Pump design

Internal gear pump

Operating and transport position

Upright or horizontal

Hydraulic fluids

Mineral oil and biodegradable fluids (HEES and HETG, see info service sheet 00.20). Other fluids on request.

Temperature range of fluids

0 °C ... +60 °C / +32 °F ... +140 °F

Ambient temperature range

0 °C ... +50 °C / +32 °F ... +122 °F

Accessories

Water-absorbing filter elements EXAPOR®AQUA. These can be used for short-term water absorption in all standard units (on request).

Trolley

Easy transport over long distances.

Viscosity range

Type	Continuous operation min.	Continuous operation max.	Short-term operation max.
FA 016-11100	15 mm ² /s 70 SUS	250 mm ² /s 1160 SUS	400 mm ² /s 1860 SUS
FA 016-11110	15 mm ² /s 70 SUS	250 mm ² /s 1160 SUS	400 mm ² /s 1860 SUS
FA 016-11300	15 mm ² /s 70 SUS	250 mm ² /s 1160 SUS	400 mm ² /s 1860 SUS
FA 016-11600	15 mm ² /s 70 SUS	250 mm ² /s 1160 SUS	400 mm ² /s 1860 SUS
FAPC 016-12105	15 mm ² /s 70 SUS	150 mm ² /s 695 SUS	150 mm ² /s* 695 SUS*
FAPC 016-12175	15 mm ² /s 70 SUS	150 mm ² /s 695 SUS	150 mm ² /s* 695 SUS*

* An exact measurement of the oil cleanliness class is only possible within a viscosity range from 15 mm²/s / 70 SUS to 150 mm²/s / 695 SUS.

Dimensions

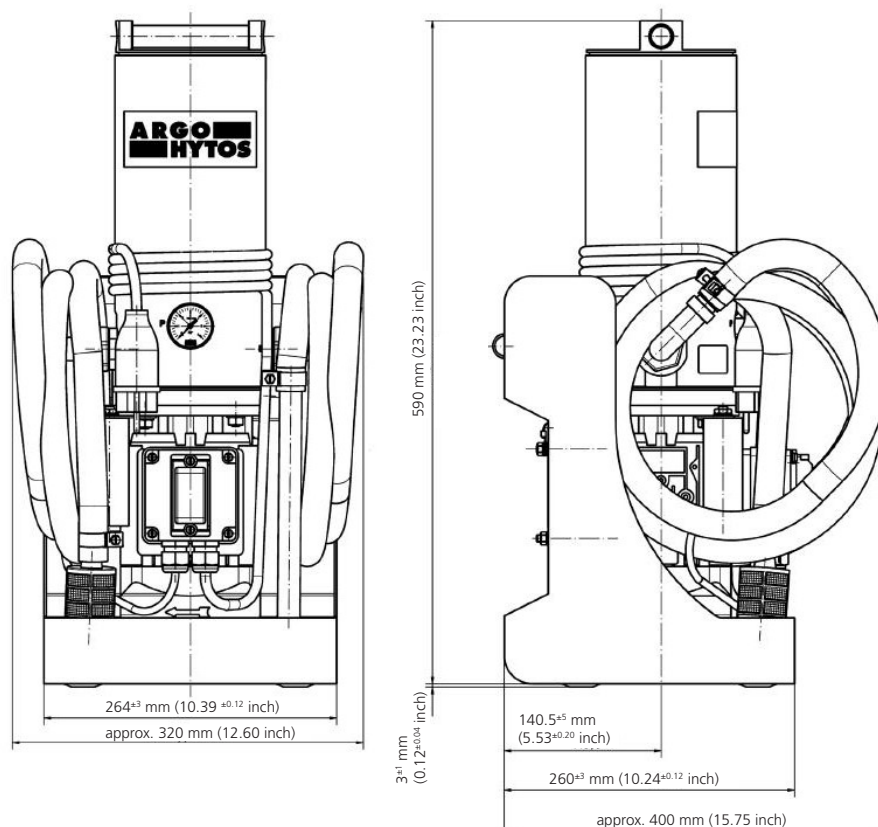

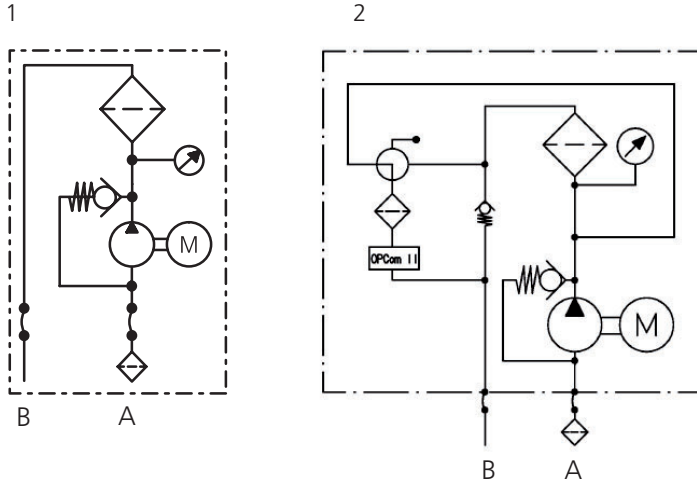

Description

Cleaning speed

The cleaning speed depends on the efficiency of the filter elements ($\beta_{x(c)}$), the nominal volume flow (Q_{nominal}) and the oil volume (V_{actual}).

In graph D1-D2, the cleaning time is shown in relation to the filter fineness (indication of cleanliness classes according to ISO 4406:1999). The values are recorded by laboratory methods and may be influenced by environmental conditions (such as continuous additional introduction of dirt on running systems, high water content, etc.).

All characteristic curves (see graphs D1-D2) relate to a **reference oil volume of 180 l / 47.5 gal** and a **nominal volume flow of 15 l/min / 4 gpm**.

The following formula should be used to convert to the actual oil volume:

$$t_{\text{actual}} = \frac{V_{\text{actual}} \cdot \Delta t}{12 \cdot Q_{\text{nominal}}}$$

- t_{actual} = actual cleaning speed
- Δt = cleaning speed for oil volume of 180 l / 47.5 gal
- V_{actual} = volume of oil to be cleaned
- Q_{nominal} = nominal volume flow, see selection chart

For monitoring purposes we recommend the OPCOM from ARGO-HYTOS, integrated in the version FAPC 016 or the OPCCount Particle Counter.

Determining the cleaning time

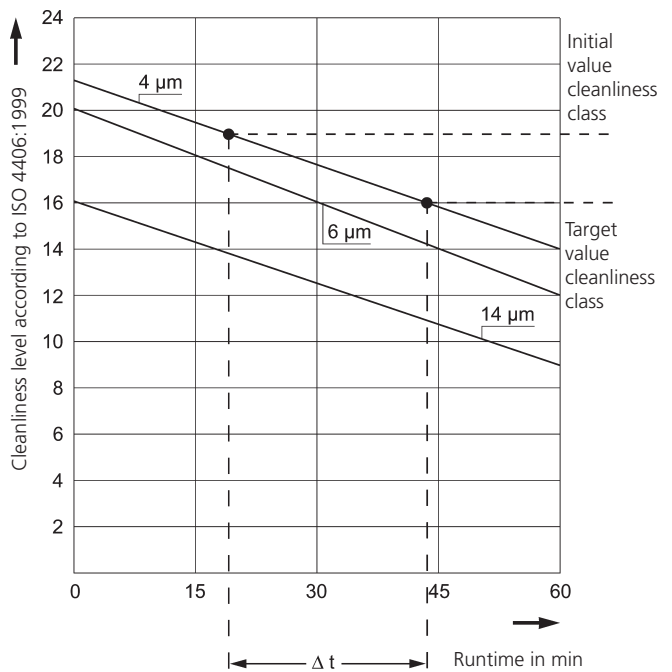

- › Determine the initial cleanliness class and enter it on the graph, e. g. 19/17/14 according to ISO 4406:1999
- › Enter the target cleanliness class on the graph, e.g. 16/14/11 according to ISO 4406:1999
- › Determine Δt , in this case $\Delta t = 25$ min
- › Insert the value in the formula, where $V_{\text{actual}} = 350$ l / 92.5 gal and $Q_{\text{nominal}} = 16$ l/min / 4.2 gpm

$$t_{\text{actual}} = \frac{V_{\text{actual}} \cdot \Delta t}{12 \cdot Q_{\text{nominal}}}$$

$$= \frac{350 (92.5) \cdot 25}{12 \cdot 16 (4.2)} \approx 46 \text{ min}$$

Curves for the cleaning time as a function of the filter fineness

FA 016 with 3EN2 and 5EN2 EXAPOR®MAX2 filter element

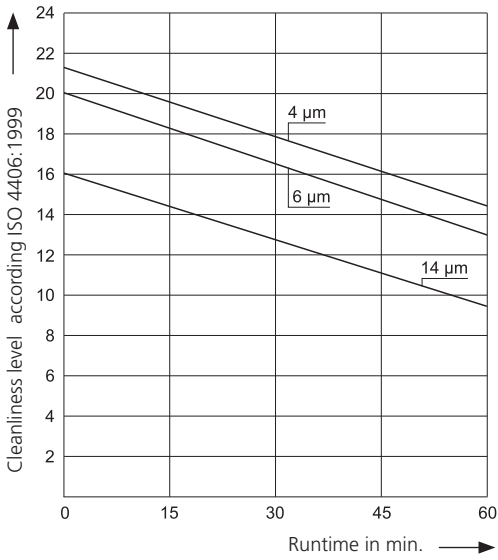

FA 016 with 10EX2 EXAPOR®MAX2 filter element

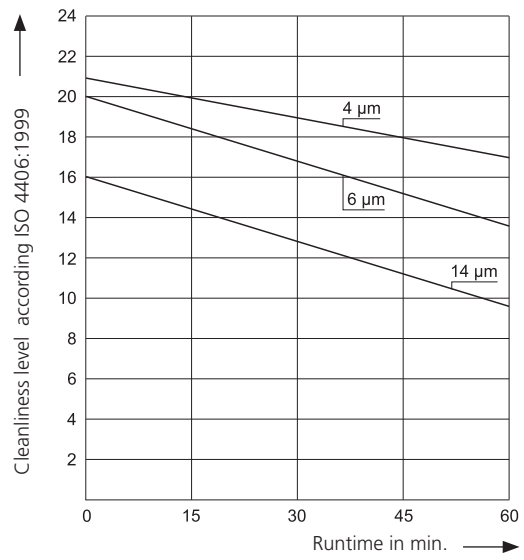

Filter fineness curves in Selection Chart

Dx Filtration ratio β as a function of particle size x obtained by the Multi-Pass Test according to ISO 16889

The abbreviations represent the following β -values resp. finenesses:

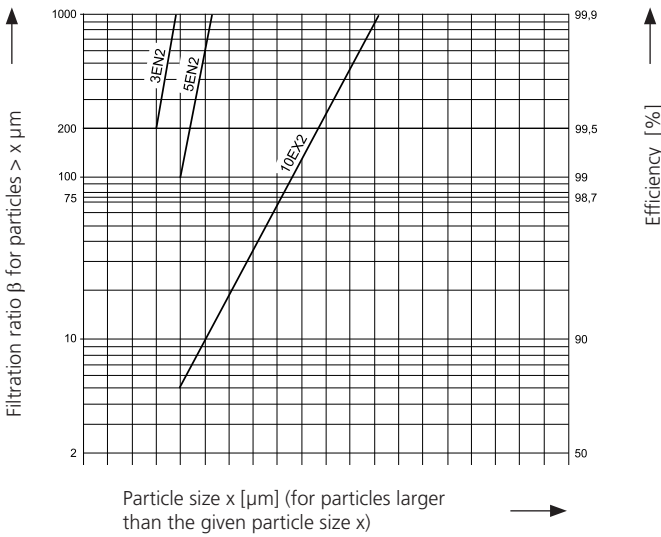

With EXAPOR®MAX2 elements:
 3EN2 = $\bar{\beta}_{3(c)} = 200$ EXAPOR®MAX 2
 5EN2 = $\bar{\beta}_{5(c)} = 200$ EXAPOR®MAX 2
 10EX2 = $\bar{\beta}_{10(c)} = 200$ EXAPOR®MAX 2

Selection Chart

	Order No.	Order No.	Order No.	Order No.	Order No.	Order No.
	FA 016-11100	FA 016-11300	FA 016-11600	FA 016-11110	FAPC 016-12105	FAPC 016-12175
Nominal flow rate	16 l/min* 4.2 gpm*	16 l/min* 4.2 gpm*	16 l/min* 4.2 gpm*	19 l/min* 5.0 gpm*	16 l/min* 4.2 gpm*	16 l/min* 4.2 gpm*
Filter fineness see Diagram Dx	3EN2	5EN2	10EX2	3EN2	3EN2	3EN2
Dirt capacity Mi at Q	280 g	270 g	210 g	280 g	280 g	280 g
E-Motor operating voltage	1 ~ 230 V	1 ~ 230 V	1 ~ 230 V	1 ~ 110 V	1 ~ 230 V	1 ~ 110 V
E-Motor operating frequency	50/60 Hz	50/60 Hz	50/60 Hz	50/60 Hz	50/60 Hz	50/60 Hz
E-Motor power	0.45 kW*	0.45 kW*	0.45 kW*	0.45 kW*	0.45 kW*	0.45 kW*
Length suction hose	1.8 m / 5.9 ft	1.8 m / 5.9 ft	1.8 m / 5.9 ft	1.8 m / 5.9 ft	1.8 m / 5.9 ft	1.8 m / 5.9 ft
Length pressure hose	2 m / 6.6 ft	2 m / 6.6 ft	2 m / 6.6 ft	2 m / 6.6 ft	2 m / 6.6 ft	2 m / 6.6 ft
Viscosity max.	400 mm ² /s 1860 SUS	400 mm ² /s 1860 SUS	400 mm ² /s 1860 SUS	400 mm ² /s 1860 SUS	150 mm ² /s 695 SUS	150 mm ² /s 695 SUS
Suction height max.	1.5 m / 4.9 ft	1.5 m / 4.9 ft	1.5 m / 4.9 ft	1.5 m / 4.9 ft	1.5 m / 4.9 ft	1.5 m / 4.9 ft
Operating pressure PRV max.	4 bar / 58 psi	4 bar / 58 psi	4 bar / 58 psi	4 bar / 58 psi	4 bar / 58 psi	4 bar / 58 psi
Symbol	1	1	1	1	2	2
Replacement element Order No.	V7.1220-113	V7.1220-13	V7.1220-06	V7.1220-113	V7.1220-113	V7.1220-113
Weight	18,9 kg 41.7 lbs	18,9 kg 41.7 lbs	18,9 kg 41.7 lbs	18,9 kg 41.7 lbs	24 kg 52.9 lbs	24 kg 52.9 lbs
Clogging indicator	Manometer	Manometer	Manometer	Manometer	Manometer	Manometer
Particle monitor	-	-	-	-	OPCom	OPCom

* Indications at 50 Hz. At 60 Hz the value increases by approx. 20 %.

Other versions on request.

Filter elements:

See selection chart.

Water-absorbing filter elements EXAPOR®AQUA - on request.

Coarse screen element S7.1220, 100 µm, cleanable and re-usable - on request.

Accessories:

- › Hose extensions on request.
- › For appropriate clogging indicators, please refer to datasheet 60.20.
- › Trolley for FA 016 and FAPC 016 Order No. FA 016-1760.
- › Suction strainer set FA 016.1775 for tank openings on request, in case the existing suction strainer cannot be used.
- › Mounting set FA 008.1700 for tank openings with ventilating filter, e.g. as service connection on request.