

3-Way Flow Regulator, Pressure Compensated, Modular

VSS1-306

Size 06 (D03) • Q_{max} 16 l/min (4 GPM) • p_{max} 320 bar (4600 PSI)



Technical Features

- › Subplate mounting interface acc. to ISO 4401, DIN 24340 (CETOP 03) for use in vertical stacking assemblies
- › Set flow rate independent of load pressure and temperature changes
- › Meter-in flow control
- › Adjusted flow rate depends on the orifice area and adjusted differential pressure
- › Quiet and modulated response to load changes
- › Adjustable by metallic hand screw
- › Fine low-torque adjustment
- › In the standard version, the steel parts are zinc-coated for 240 h protection acc. to ISO 9227 and the valve body is phosphated

Functional Description

3-Way pressure compensated flow control valves are designed to provide adjustable, controlled flow rates independently of changes in system pressure. The priority flow supplies the consumer port and excessive flow returns to the tank port. The flow control valve consists of a housing, a throttling spool, a pressure compensator, an internal spring and a hand screw to adjust the flow setting.

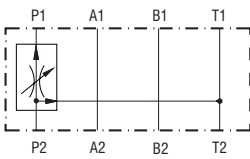

ISO 4401-03-02-0-05

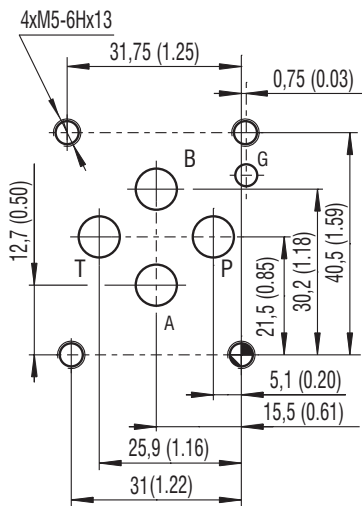

Ports P, A, B, T - max \varnothing 7.5 mm (0.29 in)

Technical Data

Valve size	06 (D03)	
Max. flow	l/min (GPM)	16 (4)
Max. operating pressure	bar (PSI)	320 (4640)
Nominal flow rates	l/min (GPM)	16 (4.2) 20 (5.3)
Min. flow rates	cm ³ (inch ³)/min	60 (3.7)
Fluid temperature range (NBR)	°C (°F)	-30 ... +100 (-22 ... +212)
Fluid temperature range (FPM)	°C (°F)	-20 ... +120 (-4 ... +248)
Maximum degree of fluid contamination	for $Q \leq (1 \text{ l/min})$ for $Q > (1 \text{ l/min})$	Class 20/17/14 according to ISO 4406 Class 21/18/15 according to ISO 4406
Max. flow rate variation at pressure change (for $Q > 2.5 Q_{min}$ and $p = 6 \dots 100\% p_{max}$)	%	± 10
Mass	kg (lbs)	0.8 (1.76)

	Datasheet	Type
General information	GI_0060	Products and operating conditions
Mounting interface / tolerances	SMT_0019	ISO 4401-03-02-0-05 DIN 24340 (CETOP 03)
Spare parts	SP_8010	

Characteristics measured at $v = 32 \text{ mm}^2/\text{s}$ (156 SUS)

Regulated flow related to input pressure

Flow direction P2 - P1

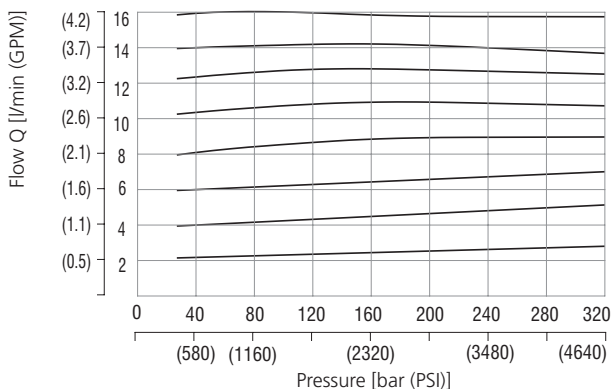

Flow rate related to indicated scale

Flow direction P2 - P1

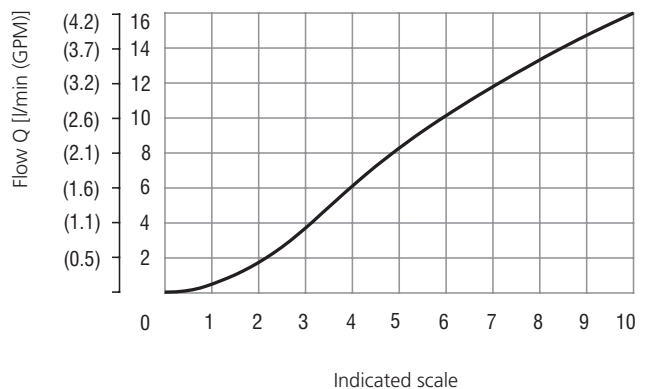

Dimensions in millimeters (inches)

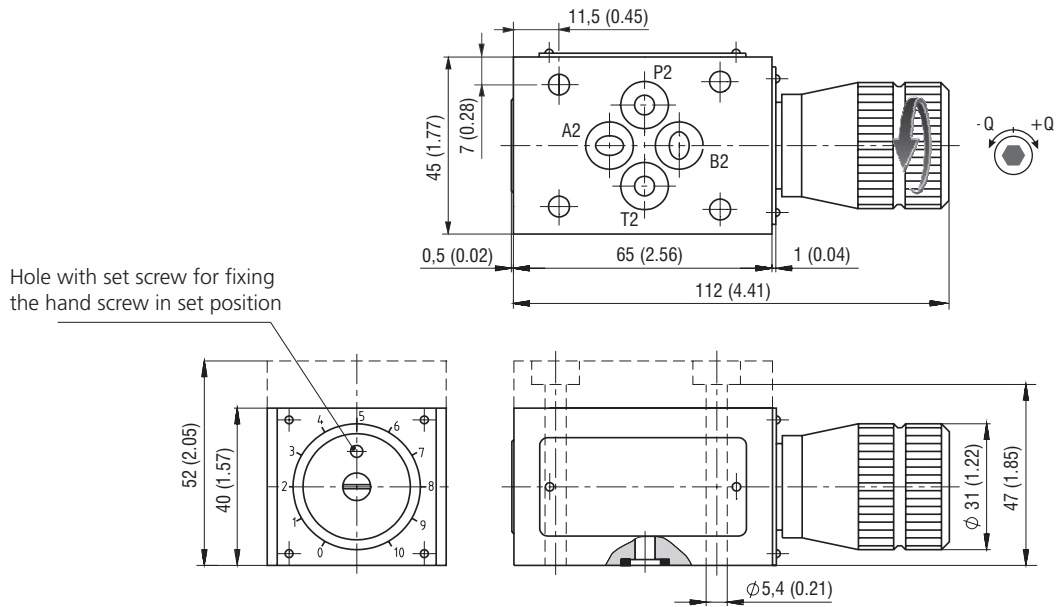

Functional symbols

Functional symbol of the valve

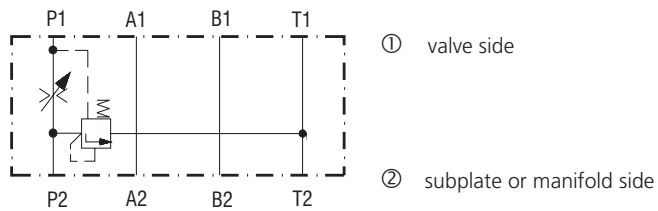

Typical application of the valve in stacking assembly*

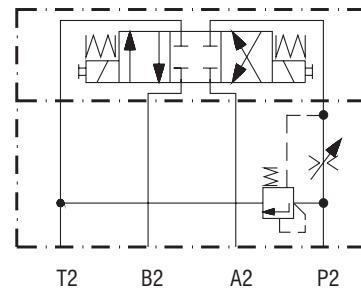

* Directional valve must be ordered separately.

Ordering Code

