

4/2 and 4/3 Directional Control Valve, Solenoid Operated

RPE4-10

Size 10 (D05) • Q_{max} 140 l/min (37 GPM) • p_{max} 350 bar (5100 PSI)

Technical Features

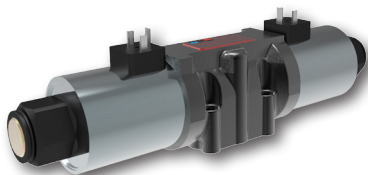

- › Direct acting directional control valve with subplate mounting interface acc. to ISO 4401, DIN 24340 (CETOP 05)
- › High transmitted hydraulic power up to 350 bar with optimized design to minimize pressure drop
- › Five chamber housing design with reduced hydraulic power dependence on fluid viscosity
- › The valve is available with interchangeable DC solenoids, also for AC power supply using a built-in rectifier bridge
- › Wide range of solenoid electrical terminal versions available
- › Wide range of interchangeable spools and manual overrides available
- › CSA Certificate upon request
- › Inductive contactless Normally Open and Normally Closed spool position sensor option
- › Soft-shift spool speed control option
- › The coil is fastened to the core tube with a retaining nut and can be rotated by 360° to suit the available space.
- › In the standard version, the valve housing is phosphated and steel parts zinc-coated for 240 h salt spray protection acc. to ISO 9227
- › Enhanced surface protection for mobile sector available (ISO 9227, 520 h salt spray)

ISO 4401-05-04-0-05

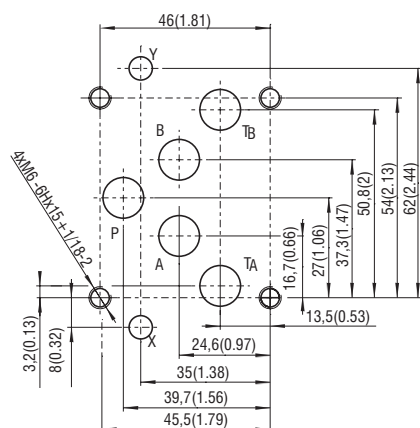

Ports P, A, B, T - max \varnothing 11.2 mm (0.44 in)

Technical Data

Valve size	10 (D05)	
Max. flow	l/min (GPM)	140 (37)
Max. operating pressure at ports P, A, B	bar (PSI)	standard 350 (5080)
Max. operating pressure at port T	bar (PSI)	210 (3050), 50 (730), for version S1, S4
Fluid temperature range (NBR)	°C (°F)	-30 ... +80 (-22 ... +176)
Fluid temperature range (FPM)	°C (°F)	-20 ... +80 (-4 ... +176)
Ambient temperature range	°C (°F)	-30 ... +50 (-22 ... +122)
Supply voltage tolerance	%	AC: \pm 10 DC: \pm 10
Max. switching frequency	1/h	15 000
Switching time at $v=32 \text{ mm}^2/\text{s}$ (156 SUS)	ON / OFF	ms
Enclosure type acc. to EN 60529	IP65 / IP67 (see Dimensions, page 3)	
Mass	kg (lbs)	3.9 (8.60) / 2.2 (11.90)
General information	Datasheet	Type
Coil types / connectors	C_8007	C31* / K*
Mounting pattern	SMT_0019	Size 10
Spare parts	SP_8010	

Characteristics measured at $v = 32 \text{ mm}^2/\text{s}$ (156 SUS)

Operating limits

Operating limits for maximum hydraulic power at rated temperature and supply voltage equal to 90% nominal.

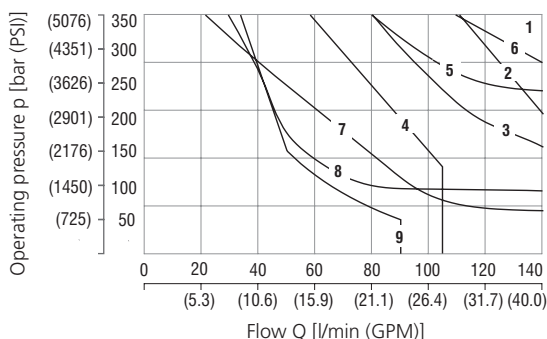

Z11, Z51, H11, H51, P11, P51	1	J15, J75	6
R11, X11, R21	2	L21	7
C11, C51	3	A51	8
B11, B51	4	C21	9
Y11, Y51	5		

Pressure drop related to flow rate

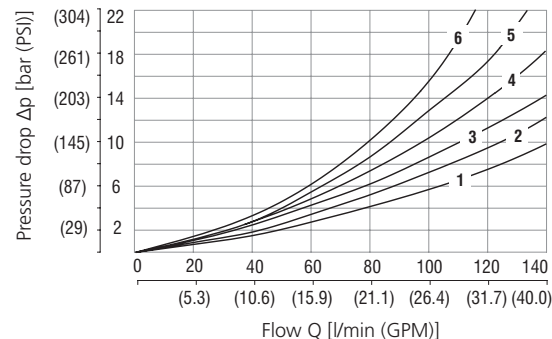

	P-A	P-B	A-T	B-T	P-T		P-A	P-B	A-T	B-T	P-T
Z11, P11, Y11, R11, X11, B11	1	1	2	2		C11	4	3	4	5	1
Z51, Y51, B51		1	2			C51	4			5	1
H11	1	1	2	2	1	L21	1	1	1	2	2
H51		1	2		1	R21	1	1	1	3	
P51		1	2			J15	1	1	2	3	
J75, A51	1	1				C21	6	6	6	6	4

For operating limits under conditions and flow directions other than shown contact our technical support. Admissible operating limits may be considerably lower with only one direction of flow (A or B plugged, or without flow.)

Ordering Code

RPE4 - 10 [] [] / [] [] [] [] [] [] [] [] - [] [] []

4/2 and 4/3
Directional Control Valve,
solenoid operated

Valve size

Number of spool positions

two positions 2
three positions 3

Spool symbols

see the table Spool symbols

Rated supply voltage of solenoids

(at the coil terminals)

12 V DC / 3.17 A 01200
24 V DC / 1.73 A 02400
27 V DC / 1.52 A 02700
205 V DC / 0.20 A 20500
120 V AC / 0.38 A / 60 Hz 12060
230 V AC / 0.20 A / 50 (60) Hz 23050

CSA upon request.

Connector

EN 175301-803-A E1
E1 with quenching diode E2
AMP Junior Timer - radial direction (2 pins; male) E3
E3 with quenching diode E4
EN 175301-803-A with integrated rectifier E5
Loose conductors (two insulated wires) E8
E8 with quenching diode E9
Deutsch DT04-2P - axial direction E12A
E12A with quenching diode E13A

- For directional valves with two solenoids, one solenoid must be de-energized before the other solenoid can be charged.
- For AC voltage supply use coils with connector type E5.
- For other solenoid voltage supply options see data sheet HA 8007.

CSA Certified
CSA marking

Surface treatment

No designation housing phosphated, steel parts
zinc-coated (ZnCr-3), ISO 9227 (240h)
A zinc-coated (ZnCr-3), ISO 9227 (240h)
B zinc-coated (ZnNi), ISO 9227 (520h)

Spool monitoring

No designation without sensors
S1 normally-open sensor, 50 bar (730 PSI)
S2 normally-open sensor, 210 bar (3050 PSI)
S4 normally-closed sensor, 50 bar (730 PSI)

Seals

No designation NBR
V FPM (Viton)

Soft-shift spool speed control

No designation without soft shift control
T2 orifice Ø0,6 mm (0.02 inch) in T line bridge
T3 adjustable needle valve in T line bridge

Manual override

No designation standard
N1 cap nut covered
N2 rubber boot protected
N4 hand screw
N5 socket head screw
N9 without manual override

- The solenoid operated valves are delivered without connectors. For available connectors see data sheet HA 8007.
- The port restrictor plugs can be ordered separately from the spare parts data sheet.
- Mounting bolts M5 x 50 DIN 912-10.9 or studs must be ordered separately. Tightening torque is 8.9 Nm (6.56 ft-lbf).
- Besides the shown, commonly used valve versions other special models are available. Contact our technical support for their identification, feasibility and operating limits. versions are available: see our technical department for their identification, feasibility and operating limits.

Spool Symbols

Type	Symbol	Interposition	Type	Symbol	Interposition
Z11			P51		
C11			Y51		
H11			C51		
P11			Z51		
Y11			B51		
L21			H51		
B11			X11		
C21			C11		
R11			H11		
R21			J15		
A51			J75		

Type of Solenoid Coil in millimeters (inches)

E1, E2 Protection degree IP65	E3, E4 Protection degree IP65	E5 Protection degree IP65	E8, E9 Protection degree IP65	E12A, E13A Protection IP67 / 69K
			 Note: A = Standard 300 mm (11.81 in), other lengths on demand	

The indicated IP protection level is only achieved if the connector is properly mounted.

Manual Override in millimeters (inches)

No designation - standard	Designation N1 - cap nut covered	Designation N2 - rubber boot protected	Designation N4 - hand screw	Designation N5 - socket head screw size 3	Designation N9 - without manual override

In case of solenoid malfunction or power failure, the spool of the valve can be shifted by manual override as long as the pressure in port T does not exceed 25 bar (363 PSI). For alternative manual overrides contact our technical support.

Spool Position Sensor

S1, S2 - Circuit diagram of the normally - **OPEN** sensor

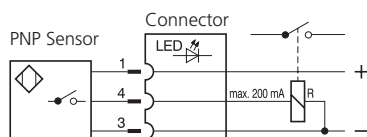

S4 - Circuit diagram of the normally - **CLOSED** sensor

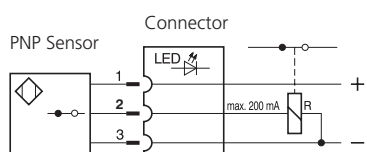

Technical Data of the Sensor		S1, S4	S2
Rated power supply voltage	V	24 DC	
Power supply voltage range	V	10 ... 30 DC	
Rated current	mA	200	
Sensor enclosure protection (EN 60529)		IP 67	
Max. operating pressure	bar (PSI)	50 (725)	210 (3046)
Switching frequency	Hz	1000	
Ambient temperature range	°C (°F)	-25 ... +80 (-13 ... +176)	
Technical Data of the Connector			
Power supply voltage range	V	10 ... 30 DC	
Ambient temperature range	°C (°F)	-25 ... +80 (-13 ... +176)	
Indicator		yellow LED	

① Signal of solenoid ③ Signal of sensor	Two-Position Directional Control Valve				
	① a(b)		③ Sa(Sb)		LED
	S1, S2	S4	S1, S2	S4	S1, S2
0	1	0	ON	OFF	
1	0	1	OFF	ON	

Three-Position Directional Control Valve									
① a(b)		③ Sa(Sb)				LED			
		S1, S2		S4		S1, S2		S4	
a	b	Sa	Sb	Sa	Sb	Sa - LED	Sb - LED	Sa - LED	Sb - LED
0	0	1	1	0	0	ON	ON	OFF	OFF
1	0	0	1	1	0	OFF	ON	ON	OFF

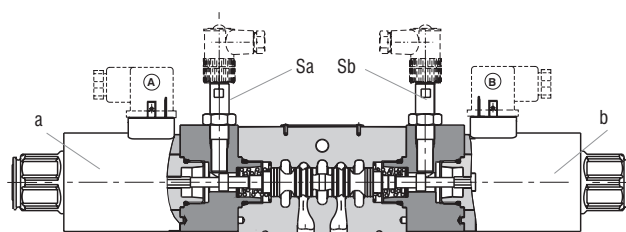
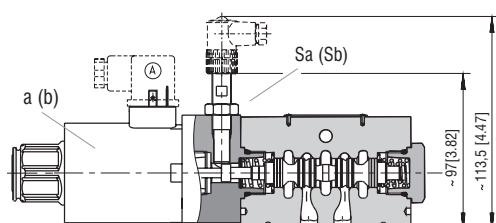

Spool Speed Control in millimeters (inches)

Designation T2 - Orifice \varnothing 0,6 (0.02)

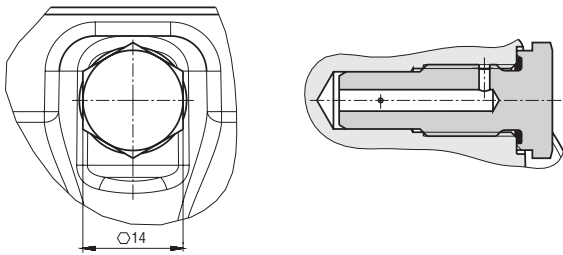

Designation T3 - Needle valve

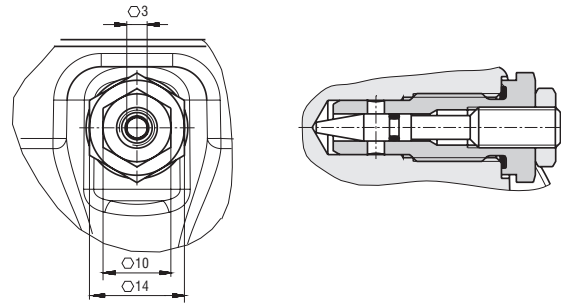

Switching time ON and OFF The orifice extends the valve shifting time.
120 ... 350 ms

The needle valve allows continuous adjustment of the shifting time.
30 ... 2000 ms

The switching times shown are valid for viscosity $\nu = 32 \text{ mm}^2/\text{s}$ (156 SUS) and nominal voltage. They depend on working pressure and flow rate of the directional control valve.

Dimensions in millimeters (inches)

Valve with two solenoids

RPE4-103*/E1

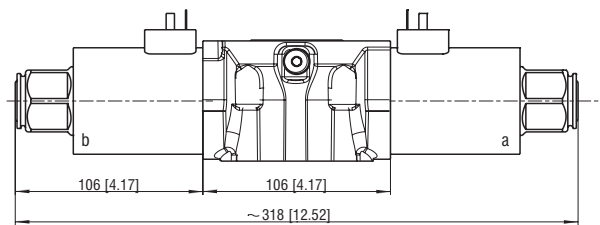
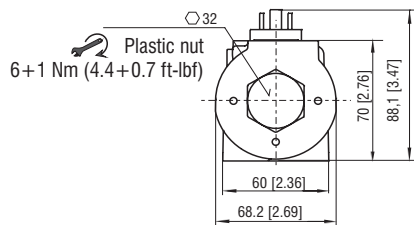

RPE4-103*/E1*S

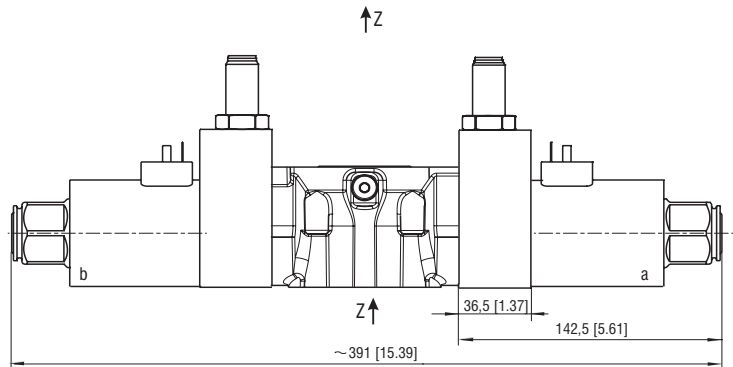
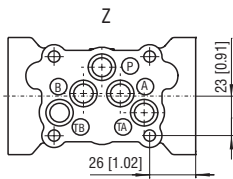

Valve with one solenoid „a”

Spool symbols R11, R21, A51, P51, Y51, C51, B51, Z51, H51

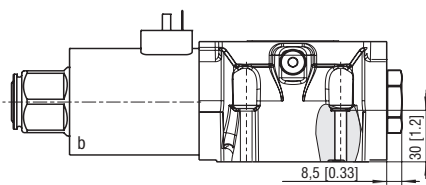

Valve with one solenoid „b”

Spool symbols X11, C11, H11

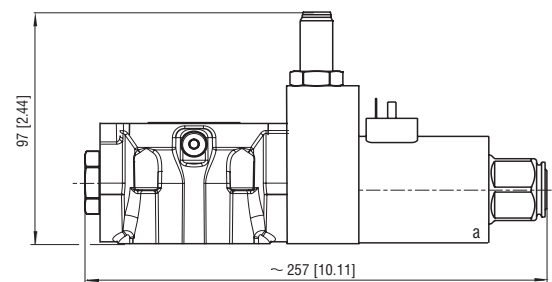
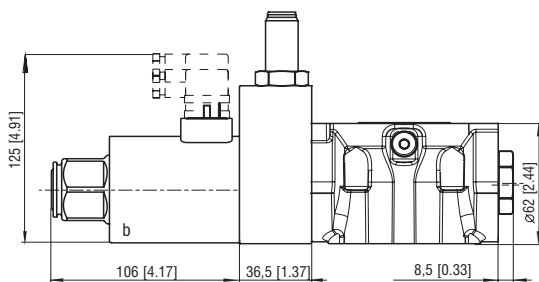
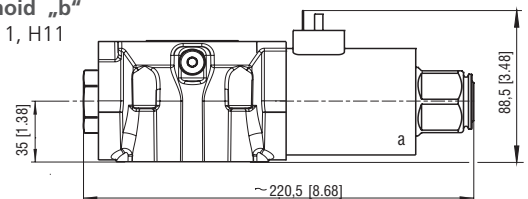

Mounting screws 14 Nm (10.3 lbf.ft)
M6 x 40 DIN 912-10.9
(for steel manifold) - not supplied