



Ventilating Filters – Vandalism Proof



L1.0808 • L1.0809

- Connection up to M42 x 2
- Nominal flow rate up to 850 l/min

Description

Application

Ventilation of tanks for hydraulic and lubrication systems, and gearboxes.

General

The oil levels in the tanks of hydraulic systems are subject to continuous variation due to temperature changes and the operation of cylinders and pressure vessels.

In order to prevent over pressure in the tanks, an exchange of air with the external atmosphere is necessary. By the use of a ventilating filter, the outside air that is drawn in is filtered and the ingress of dust is therefore prevented.

Special features

The ventilation openings are designed that dust on the surface of the tank is not drawn in, and that the ingress of spray and rainwater is largely prevented.

The use in marine applications presents no problem due to the use of synthetic materials and stainless steel.

The patented vandalism proof ventilating filters can only be removed with the special tool supplied. This makes the removal of the ventilating filter or the ingress of dirt via the filling / ventilation opening considerably more difficult.

Design

Flow direction bi-directional (air IN/OUT). The star-shaped pleating of the filter material results in:

- large filter surfaces
- low pressure drop
- high dirt-holding capacities
- long service life

Ordering options / versions

Integrated oil-level dipstick:

A dipstick can be integrated in the ventilating filter for checking the oil level. Therefore, a separate dipstick or an additional opening in the tank is not required.

Double check valves:

By the use of double check valves, the exchange of air between the tank and the environment can be considerably reduced, whereby the ingress of dust is minimized and the lifetime of the air filter element can be increased. With the double check valve, an over-pressure can be created in the tank in order to improve the suction conditions for the pumps.

A further advantage is the reduction of spray water ingress and the loss of oil through the ventilating filter.

Vandalism proof version "Standard" (L1.0808):

Ventilating filters in the patented vandalism proof version can only be removed with the special spanner supplied (A/F 47). This makes the removal of the ventilating filter or the ingress of dirt via the filling / ventilation opening considerably more difficult.

Vandalism proof version "Easy Lock" (L1.0809):

Ventilators in the patented "Easy Lock" version can only be removed with the special pin supplied.

Standard ventilating filters without vandalism proof see catalogue sheet 50.10. Filling and ventilating filters with and without vandalism proof see catalogue sheet 50.30

Maintenance

Ventilating filters should be changed at least every 1.000 operating hours, or at minimum once a year.

Characteristics

Nominal flow rate

Up to 850 l/min (see Selection Chart, column 2)

The nominal flow rates indicated by ARGO-HYTOS are based on the following criteria:

- Ventilating filters without double check valve:
 $\Delta p < 0,03$ bar
- Ventilating filters with double check valve:
 $\Delta p < 0,1$ bar for air IN

Connection

Threaded ports according to ISO 228 or DIN 13.

Sizes see Selection Chart, column 6 (other port threads on request)

Filter fineness

2 μ m

Tested in a single pass test with ISO MTD

Hydraulic fluids

Mineral oil and biodegradable fluids

(HEES and HETG, see info sheet 00.20).

Temperature range hydraulic fluid

-30 °C ... +100 °C (temporary -40 °C ... +120 °C)

Temperature range environment

-30 °C ... +100 °C

Materials

Cap:	Polyamide, GF reinforced
Base:	Polyamide, GF reinforced
Dipstick:	Stainless steel (1.4301)
Spanner:	Steel, galvanized
Gaskets:	NBR (FPM on request)
Filter media:	Composite, multi-layer

Mounting position

No limitation, position on the tank see section Layout

Diagrams

Δp -curves for complete filters in Selection Chart, column 3

D1 Pressure drop as a function of the **flow volume**
Air IN/OUT

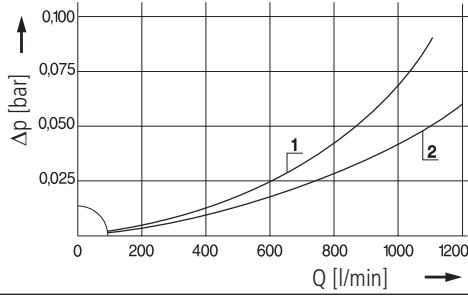

D2 Pressure drop as a function of the **flow volume**
Air IN

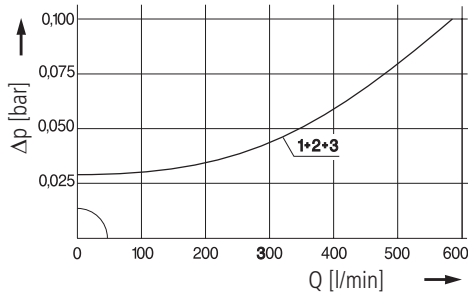

Pressure drop as a function of the **flow volume**
Air OUT

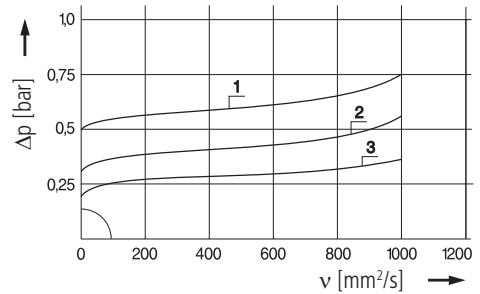

Filter fineness curves in Selection Chart, column 4

Dx Filtration ratio β as a function of particle size x tested in a single pass test with ISO MTD

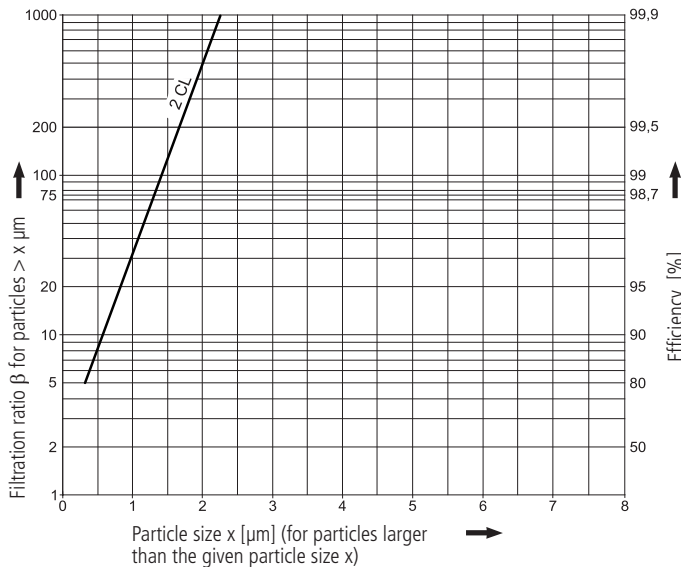

The abbreviations represent the following β -values resp. finenesses:

2CL = 2 μm Composite
99,5 % efficiency for particles of size 2 μm
tested in a single pass test with ISO MTD

For special applications, finenesses differing from these curves are also available by using special composed filter media.

Dimensions

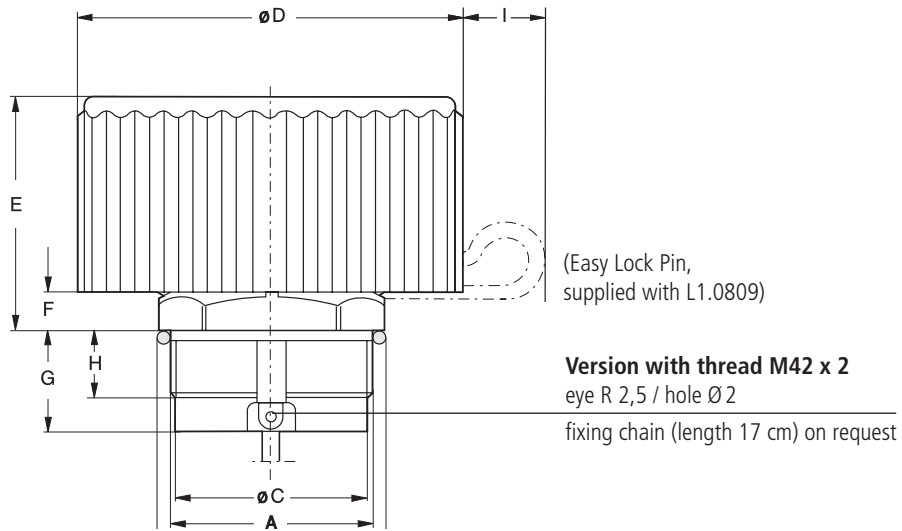

Recommended port sizes

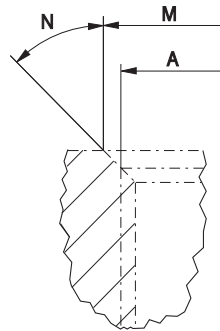

Spanner size
(special wrench, supplied with L1.0808)



Measurements

Type	A*	B	C	D	E	F	G	H	I	M	N
L1.0808	M42 x 2	AF47	40	80	50	8	21	14	-	48	45°
L1.0809	G $\frac{3}{4}$	AF33	24	80	50	7,5	17,5	13,5	16	as A	45°
	M42 x 2	AF47	40	80	50	8	21	14	16	48	45°

* The thread dimensions do not exactly conform to the DIN ISO standard thread (functioning with the DIN ISO standard thread is guaranteed)

Symbols

1

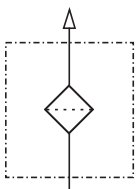

2

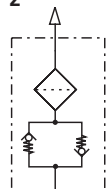

Layout

Sizes

The determining factor for selecting the size is the maximum over / under pressure allowed in the container.

For versions without double check valves, the initial pressure drop with a clean air filter should not exceed 0,03 bar.

For versions with double check valves, the initial pressure drop for air IN with a clean air filter should not exceed 0,1 bar.

Filter fineness

In the ideal case, the fineness of the ventilating filter matches the fineness of the system filter (see also CETOP RP 98 H).

By the use of filter fineness 2 CL the ingress of dust into the tank is effectively reduced.

Mounting

The ventilating filter should be mounted in a low-dust area of the machine and not in depressions in which water can collect.

For mobile use, the ventilating filter is to be mounted on the tank such that neither splashing oil from the inside nor spray water from the outside can reach the area of the ventilation opening.

Double check valves

By the use of double check valves, the exchange of air between the tank and the environment can be considerably reduced, whereby the ingress of dust is minimized and the lifetime of the air filter element is increased.

With the double check valve, a predefined level of pressure can be created in the tank in order to improve the suction conditions for the pumps.

The valve opening pressure required for the ventilating filter can be approximately determined with the ideal gas equation depending on the following system characteristics:

- differential volume
- volume of oil in the system
- volume of air in the tank
- operating temperatures

Calculation tool available.

Quality Assurance

Quality management according to DIN EN ISO 9001

To ensure constant quality in production and operation, ARGO-HYTOS filter elements undergo strict controls and tests according to the following ISO standards:

ISO 2941	Verification of collapse/burst pressure rating
ISO 2942	Verification of fabrication integrity (Bubble Point Test)
ISO 2943	Verification of material compatibility with fluids

ISO 3968	Evaluation of pressure drop versus flow characteristics
ISO 16889	Multi-Pass-Test (evaluation of filter fineness and dirt-holding capacity)
ISO 23181	Determination of resistance to flow fatigue using high viscosity fluid

Various quality controls during the production process guarantee the leakfree function and solidity of our filters.

Our engineers will be glad to advise you in questions concerning filter application, selection as well as the cleanliness class of the filtered medium attainable under practical operating conditions.

Illustrations may sometimes differ from the original. ARGO-HYTOS is not responsible for any unintentional mistake in this specification sheet.

We produce fluid power solutions

ARGO-HYTOS GMBH · Industriestraße 9 · 76703 Kraichtal-Menzingen · Germany
Phone: +49 7250 76-0 · Fax: +49 7250 76-199 · info@argo-hytos.com · www.argo-hytos.com