



Series 1000 - Size 1, 2 & 3

General

5 ways 2 or 3 positions distributors and electric distributors can be used mounted on individual or ganged bases. These standards are ISO 5599/1, according to which certain dimensions are mandatory, namely, the mounting surface, the pitch of the fastening screws, the characteristic of the electric pilot, the flow rate, the pneumatic connections, and so on.

The design is based on the balanced spool principle with pneumatic or electropneumatic actuators and resetting by mechanically or pneumatically operated spring.

The 3 position closed centres, are obtained by spring operation.

The feed to the actuators on the distributors can be provided either by pressure intake from inlet 1 (autofeed) or through the base from inlets 12 and 14 (external feed); there are two separate types of these distributors: one is the Series 1000 and the other is the Series 1010.

The Serie 1000 includes size 1 and 2 and are built of die-cast aluminium. The selection is made by turning a seal fitted between body and operator by 180°, so to utilize external-feed pilot or with internal feed.

Ordering codes are referring to distributors with "M2" mechanics or solenoid valves "S" mounted.

Coil are not included and have to be ordered separately (see Series 300).

"S" homologated c RU us solenoid coil are available (see Series 300).

Use and maintenance

This valves have an average life of 15 million cycles depending on the application and air quality.

Filtered and lubricated air using specified lubricants will reduce the wear of the seals and ensures long and trouble free operation.

Make sure that the conditions of use comply with the pressure, temperature etc. limits indicated and that the fastening screws are tightened with the following maximum torques on distributors Serie 1010.

Size 1 = 4 Nm

Size 2 = 5 Nm

Size 3 = 8 Nm

Repair kits including the spool complete with seals are available for overhauling the valves.

However, although this is a simple operation it should be carried out by a competent person.

ATTENTION: use hydraulic oil class H for lubrication such as MAGNA GC 32 (Castrol).

Construction characteristics

Series 1000	Size 1	Size 2
Body	Zinc alloy	Aluminium
Operators	Zinc alloy	Aluminium
Spools	Steel	Steel
Seals	NBR	NBR
Spacer	Technopolymer	Aluminium
Springs	Spring steel	Spring steel
Selectors	NBR	NBR

Series 1010	Size 1	Size 2	Size 3
Body	Technopolymer	Technopolymer	Aluminium
Operators	Technopolymer	Technopolymer	Aluminium
Spools	Steel	Steel	Steel
Seals	NBR	NBR	NBR
Spacer	Technopolymer	Technopolymer	Technopolymer
Pistons	Aluminium	Aluminium	Aluminium
Springs	Spring steel	Spring steel	Spring steel

1
AIR DISTRIBUTION

Pneumatic - Spring

Coding: 1001.52.1.9

Operational characteristics	
Fluid	Filtered air. No lubrication needed, if applied it shall be continuous
Max working pressure (bar)	10
Temperature °C	-5 ÷ +70
Flow rate at 6 bar with Δp=1 (NI/min)	840

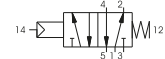
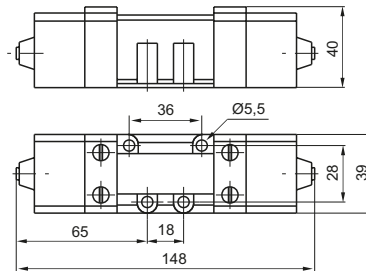

Weight 780 g
Minimum piloting pressure 2,5 bar

Pneumatic - Differential

Coding: 1001.52.1.6

Operational characteristics	
Fluid	Filtered air. No lubrication needed, if applied it shall be continuous
Max working pressure (bar)	10
Temperature °C	-5 ÷ +70
Flow rate at 6 bar with Δp=1 (NI/min)	840

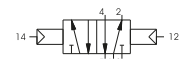
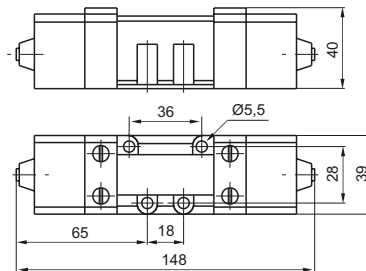

Weight 790 g
Minimum piloting pressure 2 bar

Pneumatic-Pneumatic 5/2

Coding: 1001.52.1.8

Operational characteristics	
Fluid	Filtered air. No lubrication needed, if applied it shall be continuous
Max working pressure (bar)	10
Temperature °C	-5 ÷ +70
Flow rate at 6 bar with Δp=1 (NI/min)	840

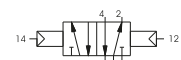
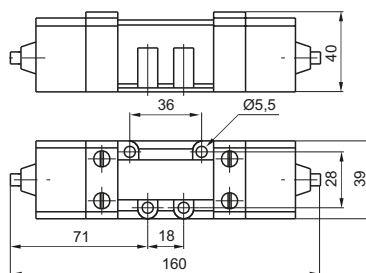

Weight 800 g
Minimum piloting pressure 1,5 bar

Pneumatic-Pneumatic 5/3

Coding: 1001.53.1.8

Operational characteristics	
Fluid	Filtered air. No lubrication needed, if applied it shall be continuous
Max working pressure (bar)	10
Temperature °C	-5 ÷ +70
Flow rate at 6 bar with Δp=1 (NI/min)	720

FUNCTION	
F 31	= Closed centres
F 32	= Open centres
F 33	= Pressured centres

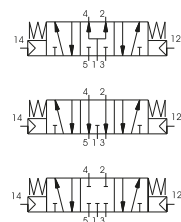
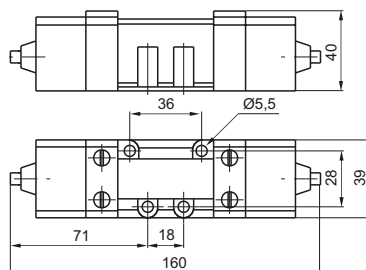

Weight 800 g
Minimum piloting pressure 3 bar

Solenoid - Spring

Coding: 1051.52.3.9.M2

Operational characteristics	
Fluid	Filtered air. No lubrication needed, if applied it shall be continuous
Max working pressure (bar)	10
Temperature °C	-5 ÷ +50
Flow rate at 6 bar with Δp=1 (NI/min)	840

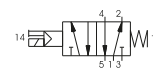
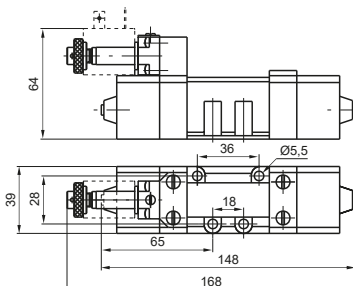
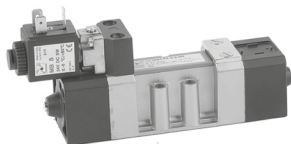

Weight 890 g
Minimum piloting pressure 2,5 bar

Solenoid-Differential

Coding: 1051.52.3.6.M2

Operational characteristics	
Fluid	Filtered air. No lubrication needed, if applied it shall be continuous
Max working pressure (bar)	10
Temperature °C	-5 ÷ +50
Flow rate at 6 bar with Δp=1 (NI/min)	840

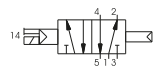
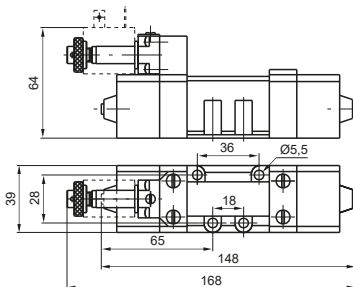
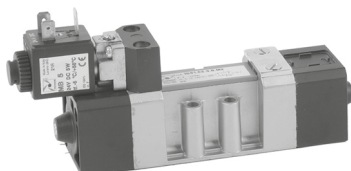

Weight 900 g
Minimum piloting pressure 2 bar

Solenoid-Solenoid 5/2

Coding: 1051.52.3.5.M2

Operational characteristics	
Fluid	Filtered air. No lubrication needed, if applied it shall be continuous
Max working pressure (bar)	10
Temperature °C	-5 ÷ +50
Flow rate at 6 bar with Δp=1 (NI/min)	840

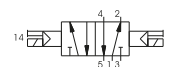
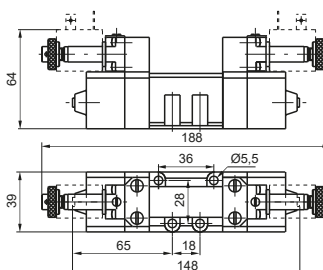
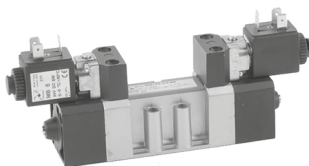

Weight 1040 g
Minimum piloting pressure 1,5 bar

Solenoid-Solenoid 5/3

Coding: 1051.53.F.3.5.M2

Operational characteristics	
Fluid	Filtered air. No lubrication needed, if applied it shall be continuous
Max working pressure (bar)	10
Temperature °C	-5 ÷ +50
Flow rate at 6 bar with Δp=1 (NI/min)	720

FUNCTION
F 31 = Closed centres
32 = Open centres
33 = Pressured centres

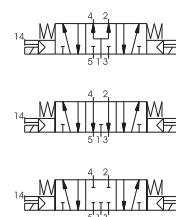
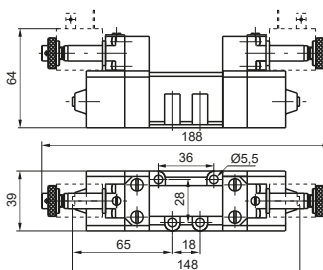
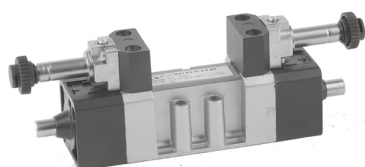

Weight 1040 g
Minimum piloting pressure 3 bar

Pneumatic - Differential

Coding: 1002.52.1.6

Operational characteristics	
Fluid	Filtered air. No lubrication needed, if applied it shall be continuous
Max working pressure (bar)	10
Temperature °C	-5 ÷ +70
Flow rate at 6 bar with $\Delta p=1$ (NI/min)	1700

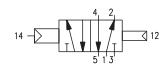
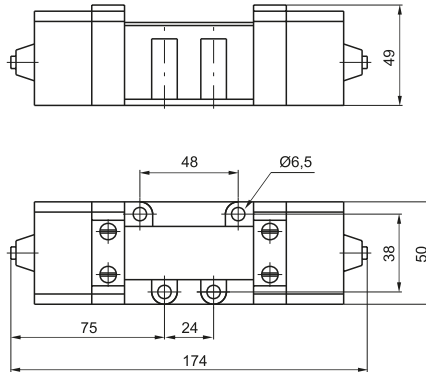
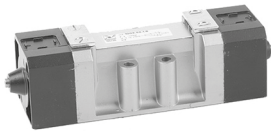

Weight 730 g
Minimum piloting pressure 2 bar

Pneumatic-Pneumatic 5/2

Coding: 1002.52.1.8

Operational characteristics	
Fluid	Filtered air. No lubrication needed, if applied it shall be continuous
Max working pressure (bar)	10
Temperature °C	-5 ÷ +70
Flow rate at 6 bar with $\Delta p=1$ (NI/min)	1700

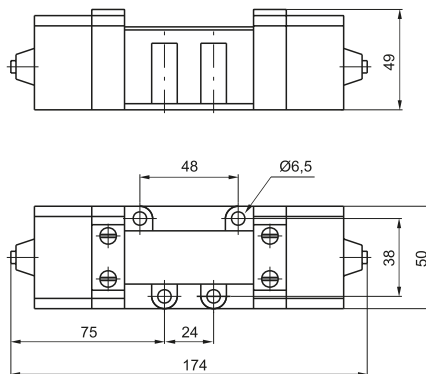

Weight 800 g
Minimum piloting pressure 1,5 bar

Pneumatic-Pneumatic 5/3

Coding: 1002.53.1.8

Operational characteristics	
Fluid	Filtered air. No lubrication needed, if applied it shall be continuous
Max working pressure (bar)	10
Temperature °C	-5 ÷ +70
Flow rate at 6 bar with $\Delta p=1$ (NI/min)	1700

FUNCTION	
F 31	= Closed centres
32	= Open centres
33	= Pressured centres

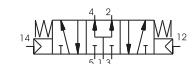
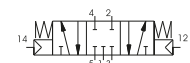
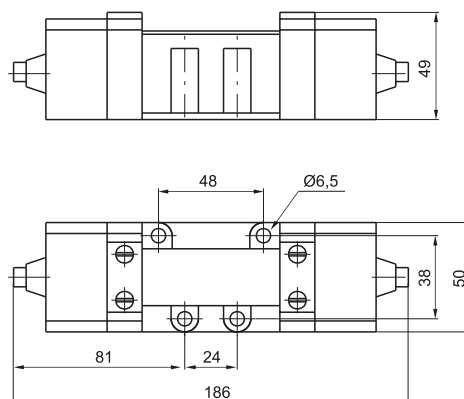

Weight 740 g
Minimum piloting pressure 3 bar

Solenoid-Differential

Coding: 1052.52.3.6.M2

Operational characteristics	
Fluid	Filtered air. No lubrication needed, if applied it shall be continuous
Max working pressure (bar)	10
Temperature °C	-5 ÷ +50
Flow rate at 6 bar with $\Delta p=1$ (NI/min)	1700

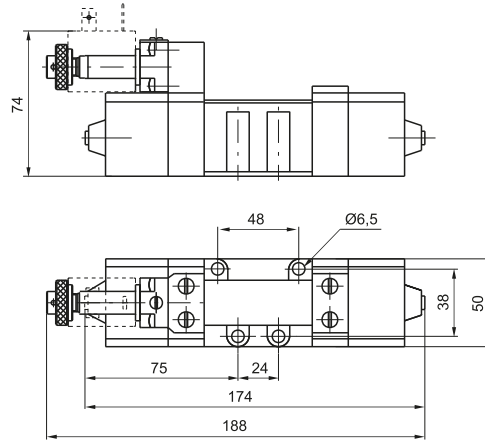

Weight 850 g
Minimum piloting pressure 2 bar

Solenoid-Solenoid 5/2

Coding: 1052.52.3.5.M2

Operational characteristics	
Fluid	Filtered air. No lubrication needed, if applied it shall be continuous
Max working pressure (bar)	10
Temperature °C	-5 ÷ +50
Flow rate at 6 bar with $\Delta p=1$ (NI/min)	1700

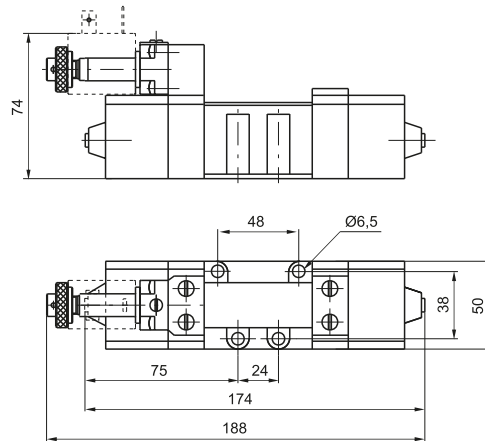

Weight 980 g
Minimum piloting pressure 1,5 bar

Solenoid-Solenoid 5/3

Coding: 1052.53.F.3.5.M2

Operational characteristics	
Fluid	Filtered air. No lubrication needed, if applied it shall be continuous
Max working pressure (bar)	10
Temperature °C	-5 ÷ +50
Flow rate at 6 bar with $\Delta p=1$ (NI/min)	1700

FUNCTION	
F	31 = Closed centres
	32 = Open centres
	33 = Pressured centres

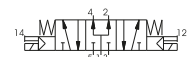
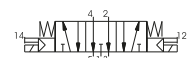
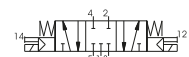
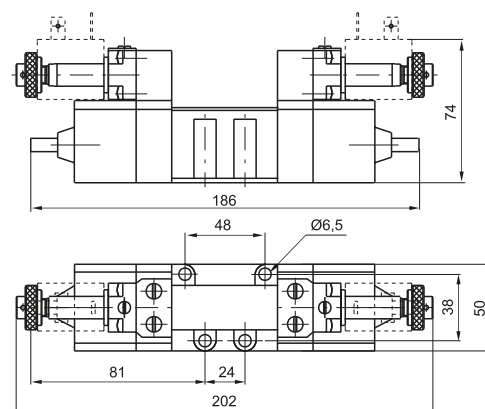

Weight 980 g
Minimum piloting pressure 3 bar

► Base for 32 mm Solenoid valve

Coding: 1001.05

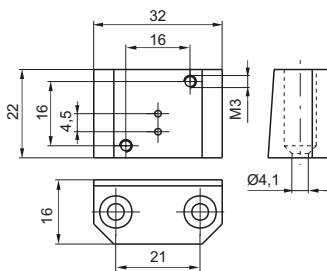

Weight 60 g

► Base CNOMO for 32 mm Solenoid valve

Coding: 1001.04

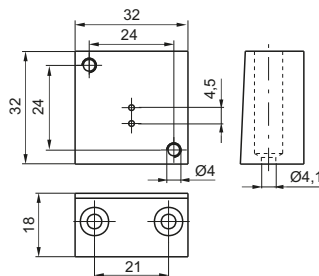
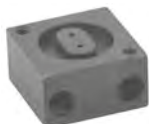

Weight 90 g

► Base with bottom connections size 1

Coding: 1001.00

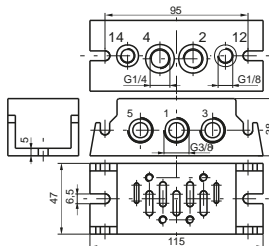

Weight 320 g
1=INLET PORT 2-4=OUTLET PORTS
3-5=EXHAUST PORTS 12-14=PILOT PORTS

► Base with side connections size 1

Coding: 1001.01

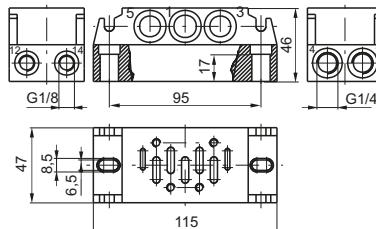

Weight 445 g
1=INLET PORT 2-4=OUTLET PORTS
3-5=EXHAUST PORTS 12-14=PILOT PORTS

► Inlet blocks

Coding: 1001.02

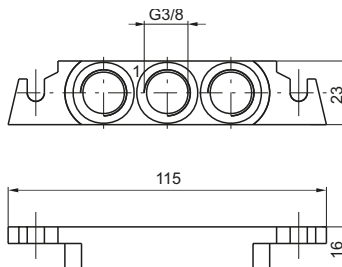

Weight 55 g

► Base with bottom connections size 2

Coding: 1002.00

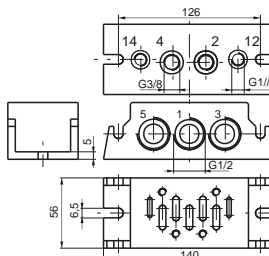

Weight 520 g
1=INLET PORT 2-4=OUTLET PORTS
3-5=EXHAUST PORTS 12-14=PILOT PORTS

Pneumatic - Spring

Coding: 1011.52.1.9

Operational characteristics	
Fluid	Filtered air. No lubrication needed, if applied it shall be continuous
Max working pressure (bar)	10
Temperature °C	-5 ÷ +50
Flow rate at 6 bar with Δp=1 (NI/min)	900

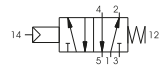
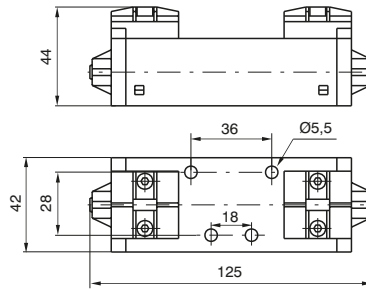

Weight 230 g
Minimum piloting pressure 2,5 bar

Pneumatic - Differential

Coding: 1011.52.1.6

Operational characteristics	
Fluid	Filtered air. No lubrication needed, if applied it shall be continuous
Max working pressure (bar)	10
Temperature °C	-5 ÷ +50
Flow rate at 6 bar with Δp=1 (NI/min)	900

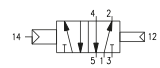
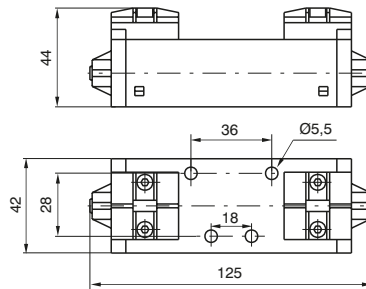

Weight 240 g
Minimum piloting pressure 2 bar

Pneumatic-Pneumatic 5/2

Coding: 1011.52.1.8

Operational characteristics	
Fluid	Filtered air. No lubrication needed, if applied it shall be continuous
Max working pressure (bar)	10
Temperature °C	-5 ÷ +50
Flow rate at 6 bar with Δp=1 (NI/min)	900

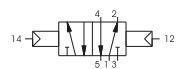
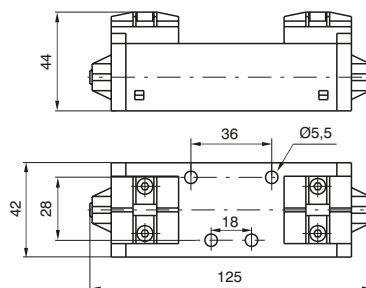
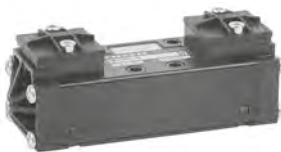

Weight 240 g
Minimum piloting pressure 1,5 bar

Pneumatic-Pneumatic 5/3

Coding: 1011.53.1.8

Operational characteristics	
Fluid	Filtered air. No lubrication needed, if applied it shall be continuous
Max working pressure (bar)	10
Temperature °C	-5 ÷ +50
Flow rate at 6 bar with Δp=1 (NI/min)	900

FUNCTION
31 = Closed centres
32 = Open centres
33 = Pressured centres

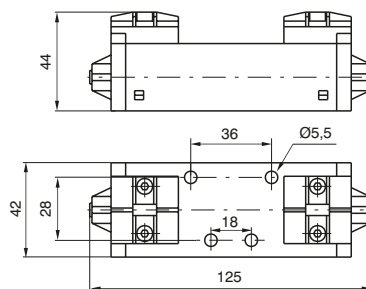
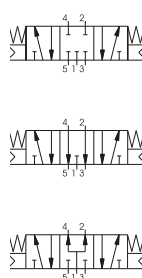

Weight 240 g
Minimum piloting pressure 3 bar



ISO 5599-1 valves and solenoid valves
Series 1000 - Technopolymer solenoid valves 5/2 - 5/3 - Size 1

AIR DISTRIBUTION 1

Solenoid - Spring

Coding: 1011.52.3.9. **M**

Operational characteristics	
Fluid	Filtered air. No lubrication needed, if applied it shall be continuous
Max working pressure (bar)	10
Temperature °C	-5 ÷ +50
Flow rate at 6 bar with Δp=1 (NI/min)	900

M	MECHANICAL CODE SEE VALVES SERIES 300 CNOMO
----------	--

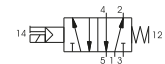
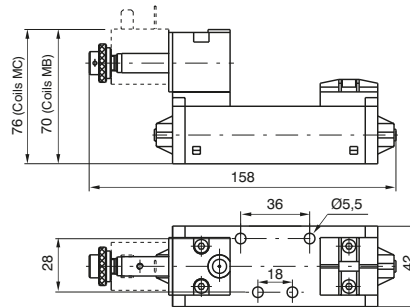

Weight 290 g
Minimum piloting pressure 2,5 bar

Solenoid-Differential

Coding: 1011.52.3.6. **M**

Operational characteristics	
Fluid	Filtered air. No lubrication needed, if applied it shall be continuous
Max working pressure (bar)	10
Temperature °C	-5 ÷ +50
Flow rate at 6 bar with Δp=1 (NI/min)	900

M	MECHANICAL CODE SEE VALVES SERIES 300 CNOMO
----------	--

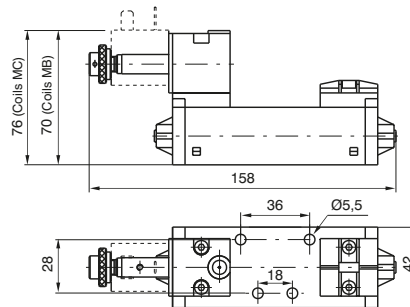

Weight 290 g
Minimum piloting pressure 2 bar

Solenoid-Solenoid 5/2

Coding: 1011.52.3.5. **M**

Operational characteristics	
Fluid	Filtered air. No lubrication needed, if applied it shall be continuous
Max working pressure (bar)	10
Temperature °C	-5 ÷ +50
Flow rate at 6 bar with Δp=1 (NI/min)	900

M	MECHANICAL CODE SEE VALVES SERIES 300 CNOMO
----------	--

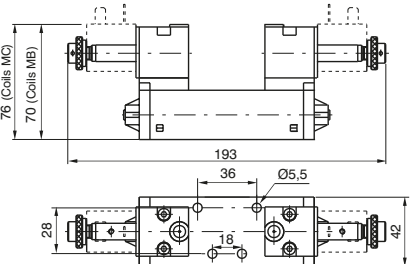

Weight 350 g
Minimum piloting pressure 1,5 bar

Solenoid-Solenoid 5/3

Coding: 1011.53. **F**.3.5. **M**

Operational characteristics	
Fluid	Filtered air. No lubrication needed, if applied it shall be continuous
Max working pressure (bar)	10
Temperature °C	-5 ÷ +50
Flow rate at 6 bar with Δp=1 (NI/min)	900

F	FUNCTION 31 = Closed centres 32 = Open centres 33 = Pressured centres
M	MECHANICAL CODE SEE VALVES SERIES 300 CNOMO

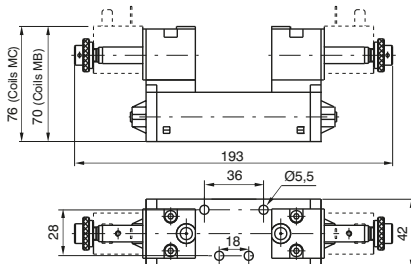
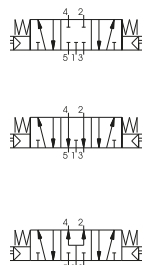

Weight 350 g
Minimum piloting pressure 3 bar

Pneumatic - Spring

Coding: 1012.52.1.9

Operational characteristics	
Fluid	Filtered air. No lubrication needed, if applied it shall be continuous
Max working pressure (bar)	10
Temperature °C	-5 ÷ +50
Flow rate at 6 bar with $\Delta p=1$ (NI/min)	1600

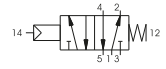
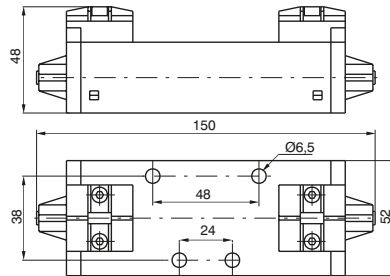

Weight 300 g
Minimum piloting pressure 2,5 bar

Pneumatic - Differential

Coding: 1012.52.1.6

Operational characteristics	
Fluid	Filtered air. No lubrication needed, if applied it shall be continuous
Max working pressure (bar)	10
Temperature °C	-5 ÷ +50
Flow rate at 6 bar with $\Delta p=1$ (NI/min)	1600

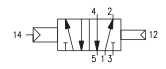
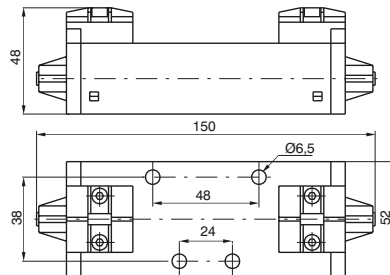

Weight 310 g
Minimum piloting pressure 2 bar

Pneumatic-Pneumatic 5/2

Coding: 1012.52.1.8

Operational characteristics	
Fluid	Filtered air. No lubrication needed, if applied it shall be continuous
Max working pressure (bar)	10
Temperature °C	-5 ÷ +50
Flow rate at 6 bar with $\Delta p=1$ (NI/min)	1600

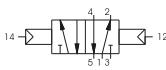
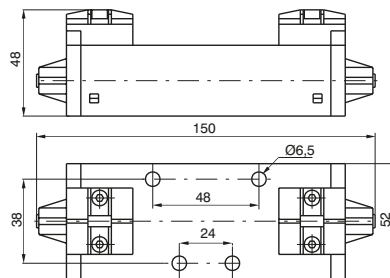

Weight 310 g
Minimum piloting pressure 1,5 bar

Pneumatic-Pneumatic 5/3

Coding: 1012.53.1.8

Operational characteristics	
Fluid	Filtered air. No lubrication needed, if applied it shall be continuous
Max working pressure (bar)	10
Temperature °C	-5 ÷ +50
Flow rate at 6 bar with $\Delta p=1$ (NI/min)	1600

FUNCTION
F 31 = Closed centres
32 = Open centres
33 = Pressured centres

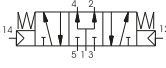
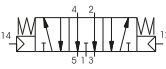
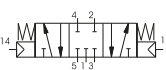
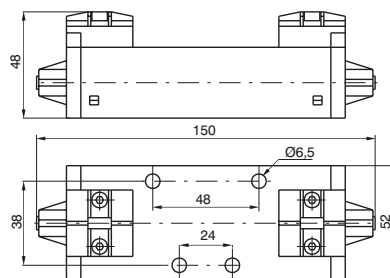

Weight 310 g
Minimum piloting pressure 3 bar

1012.53.1.8

Solenoid - Spring

Coding: 1012.52.3.9.M

Operational characteristics	
Fluid	Filtered air. No lubrication needed, if applied it shall be continuous
Max working pressure (bar)	10
Temperature °C	-5 ÷ +50
Flow rate at 6 bar with Δp=1 (NI/min)	1600

M	MECHANICAL CODE SEE VALVES SERIES 300 CNOMO
---	--

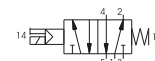
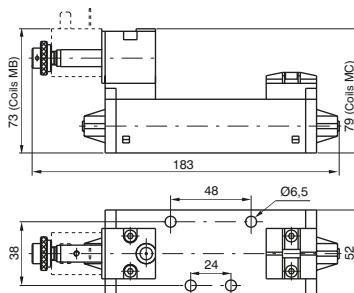

Weight 360 g
Minimum piloting pressure 2,5 bar

Solenoid-Differential

Coding: 1012.52.3.6.M

Operational characteristics	
Fluid	Filtered air. No lubrication needed, if applied it shall be continuous
Max working pressure (bar)	10
Temperature °C	-5 ÷ +50
Flow rate at 6 bar with Δp=1 (NI/min)	1600

M	MECHANICAL CODE SEE VALVES SERIES 300 CNOMO
---	--

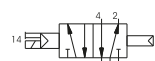
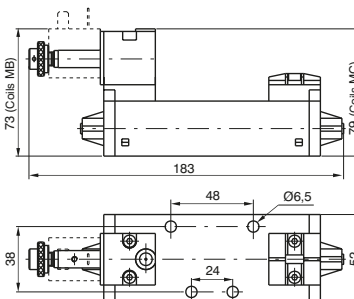

Weight 360 g
Minimum piloting pressure 2 bar

Solenoid-Differential

Coding: 1012.52.3.5.M

Operational characteristics	
Fluid	Filtered air. No lubrication needed, if applied it shall be continuous
Max working pressure (bar)	10
Temperature °C	-5 ÷ +50
Flow rate at 6 bar with Δp=1 (NI/min)	1600

M	MECHANICAL CODE SEE VALVES SERIES 300 CNOMO
---	--

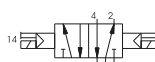
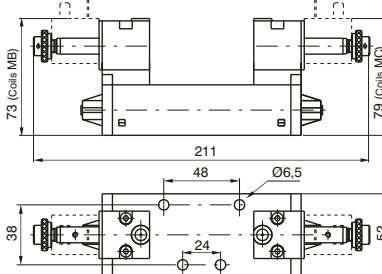

Weight 420 g
Minimum piloting pressure 1,5 bar

Solenoid-Solenoid 5/3

Coding: 1012.53.F.3.5.M

Operational characteristics	
Fluid	Filtered air. No lubrication needed, if applied it shall be continuous
Max working pressure (bar)	10
Temperature °C	-5 ÷ +50
Flow rate at 6 bar with Δp=1 (NI/min)	1600

F	FUNCTION 31 = Closed centres 32 = Open centres 33 = Pressured centres
M	MECHANICAL CODE SEE VALVES SERIES 300 CNOMO

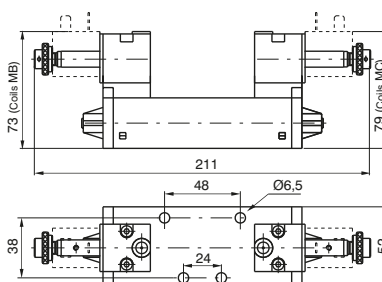
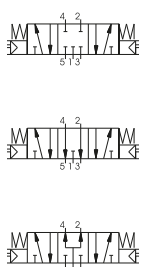

Weight 420 g
Minimum piloting pressure 3 bar

1012.53.F.3.5.M

Pneumatic - Spring

Coding: 1013.52.1.9

Operational characteristics	
Fluid	Filtered air. No lubrication needed, if applied it shall be continuous
Max working pressure (bar)	10
Temperature °C	-5 ÷ +50
Flow rate at 6 bar with Δp=1 (NI/min)	3600

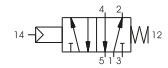
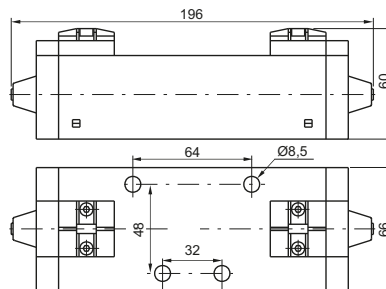

Weight 1000 g
Minimum piloting pressure 2,5 bar

Pneumatic - Differential

Coding: 1013.52.1.6

Operational characteristics	
Fluid	Filtered air. No lubrication needed, if applied it shall be continuous
Max working pressure (bar)	10
Temperature °C	-5 ÷ +50
Flow rate at 6 bar with Δp=1 (NI/min)	3600

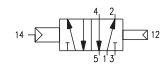
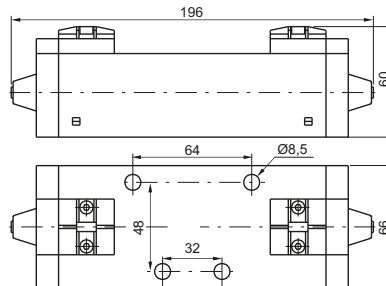

Weight 1020 g
Minimum piloting pressure 2 bar

Pneumatic-Pneumatic 5/2

Coding: 1013.52.1.8

Operational characteristics	
Fluid	Filtered air. No lubrication needed, if applied it shall be continuous
Max working pressure (bar)	10
Temperature °C	-5 ÷ +50
Flow rate at 6 bar with Δp=1 (NI/min)	3600

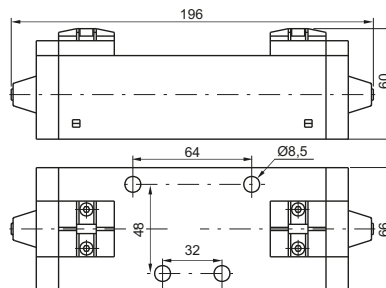

Weight 1050 g
Minimum piloting pressure 1,5 bar

Pneumatic-Pneumatic 5/3

Coding: 1013.53.1.8

Operational characteristics	
Fluid	Filtered air. No lubrication needed, if applied it shall be continuous
Max working pressure (bar)	10
Temperature °C	-5 ÷ +50
Flow rate at 6 bar with Δp=1 (NI/min)	3000

FUNCTION
F 31 = Closed centres
32 = Open centres
33 = Pressured centres

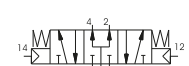
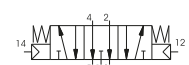
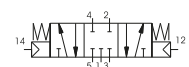
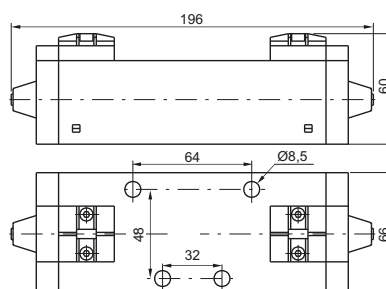

Weight 1050 g
Minimum piloting pressure 3 bar

1013.53.1.8

Solenoid - Spring

Coding: 1013.52.3.9.M

Operational characteristics	
Fluid	Filtered air. No lubrication needed, if applied it shall be continuous
Max working pressure (bar)	10
Temperature °C	-5 ÷ +50
Flow rate at 6 bar with Δp=1 (NI/min)	3600

M	MECHANICAL CODE SEE VALVES SERIES 300 CNOMO
---	--

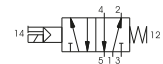
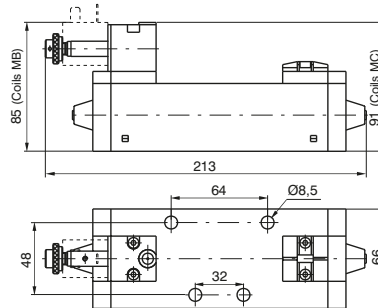

Weight 1060 g
Minimum piloting pressure 2,5 bar

Solenoid-Differential

Coding: 1013.52.3.6.M

Operational characteristics	
Fluid	Filtered air. No lubrication needed, if applied it shall be continuous
Max working pressure (bar)	10
Temperature °C	-5 ÷ +50
Flow rate at 6 bar with Δp=1 (NI/min)	3600

M	MECHANICAL CODE SEE VALVES SERIES 300 CNOMO
---	--

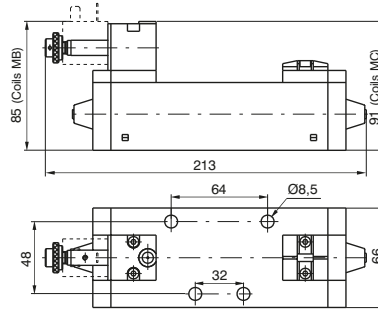

Weight 1080 g
Minimum piloting pressure 2 bar

Solenoid-Solenoid 5/2

Coding: 1013.52.3.5.M

Operational characteristics	
Fluid	Filtered air. No lubrication needed, if applied it shall be continuous
Max working pressure (bar)	10
Temperature °C	-5 ÷ +50
Flow rate at 6 bar with Δp=1 (NI/min)	3600

M	MECHANICAL CODE SEE VALVES SERIES 300 CNOMO
---	--

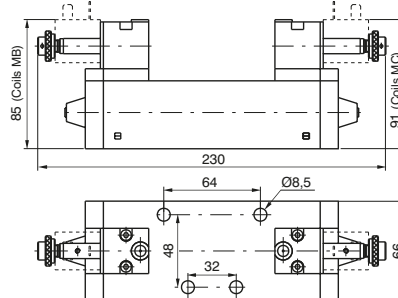

Weight 1170 g
Minimum piloting pressure 1,5 bar

Solenoid-Solenoid 5/3

Coding: 1013.53.F.3.5.M

Operational characteristics	
Fluid	Filtered air. No lubrication needed, if applied it shall be continuous
Max working pressure (bar)	10
Temperature °C	-5 ÷ +50
Flow rate at 6 bar with Δp=1 (NI/min)	3000

F	FUNCTION 31 = Closed centres 32 = Open centres 33 = Pressured centres
M	MECHANICAL CODE SEE VALVES SERIES 300 CNOMO

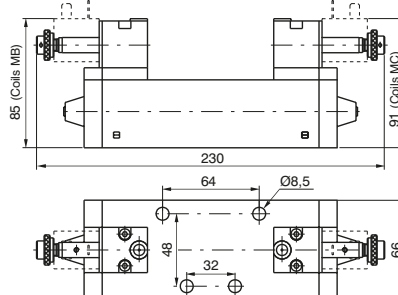
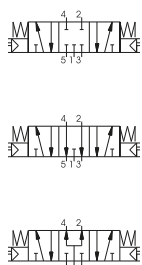

Weight 1170 g
Minimum piloting pressure 3 bar

1013.53.F.3.5.M



Series 1100 - Modular bases with side and bottom connections

General

These bases are manufactured with the outlet and pilot ports on both the sides and the bottom faces giving the option for use with any application.

Unused ports must be blanked off using threaded plugs which are not included in the part number or price.

To isolate bases from each other for use with different supply pressures ports 1, 3 & 5 should be plugged underneath the seal.

The codes are:

1101.17 (size 1) - 1102.17 (size 2) - 1103.17 (size 3)

Modular bases

Coding: 110T.00

SIZE	
T 1	= Size 1
2	= Size 2
3	= Size 3

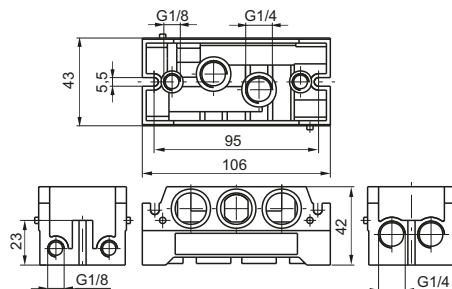

Weight 240 g

1101.00

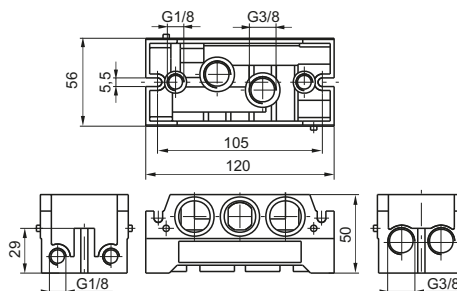

Weight 340 g

1102.00

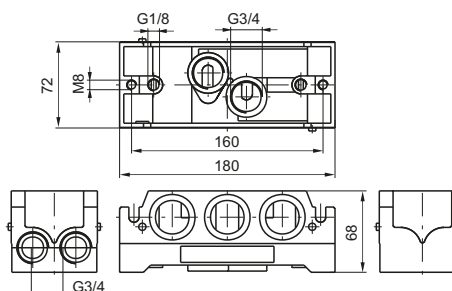

Weight 950 g

1103.00

Inlet blocks, Size 1

Coding: 1101.09

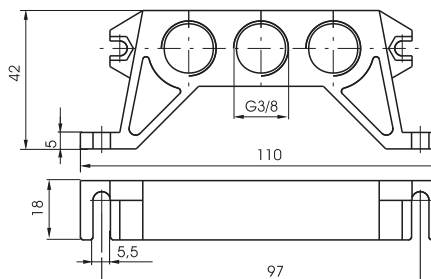

Weight 100 g

Inlet blocks, Size 3

Coding: 1103.11

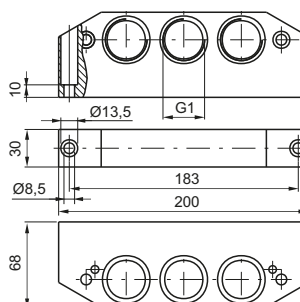

Weight 840 g

AIR DISTRIBUTION

1

Inlet blocks

Coding: 110**T**.**N**



Weight 160 g

1101.**N**

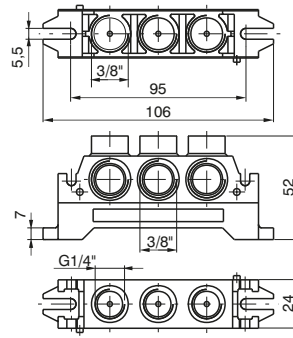

	SIZE
T	1 = Size 1 2 = Size 2
	WORKING PORTS SIZE
N	10 = Universal 11 = In line 12 = Top connections 13 = Bottom connections



Weight 230 g

1102.**N**

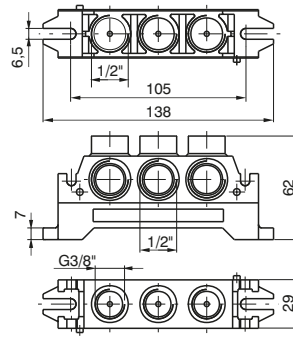

1
AIR DISTRIBUTION

Single use bases

Coding: 110**T.F**

	SIZE
T	1 = Size 1 2 = Size 2 3 = Size 3
	SHAPE
F	14 = Shape A 15 = Shape B (only for sizes 1 & 2)

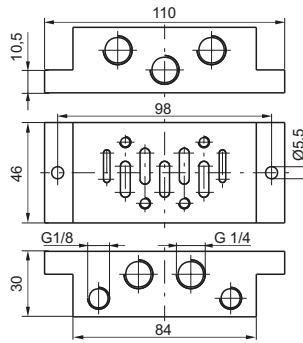

Weight 160 g

1101.14

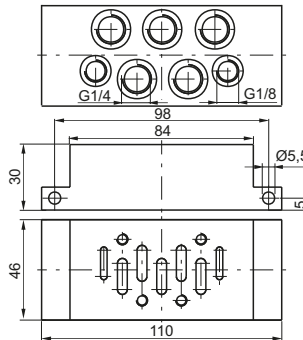

Weight 190 g

1101.15

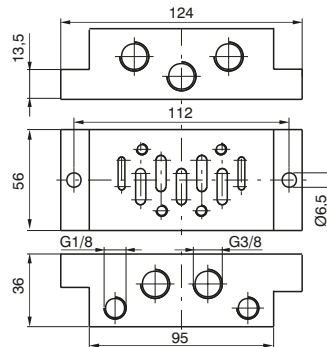

Weight 190 g

1102.14

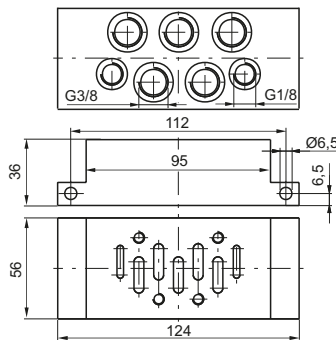
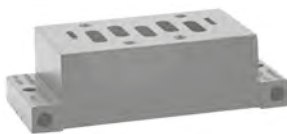

Weight 220 g

1102.15

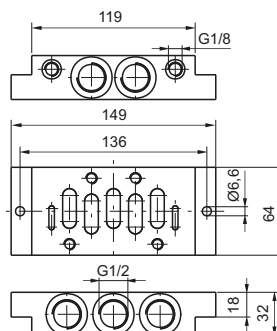
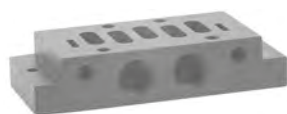

Weight 600 g

1103.14

AIR DISTRIBUTION

1

▶ Closing plate

Coding: 1100.1.16

SIZE
1 = Size 1
2 = Size 2
3 = Size 3



1101.16

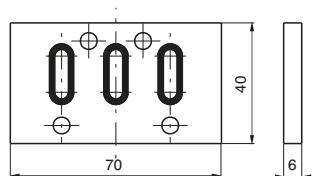

1102.16

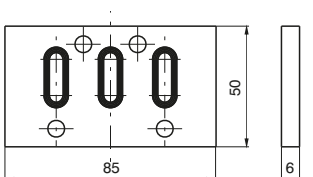

1103.16

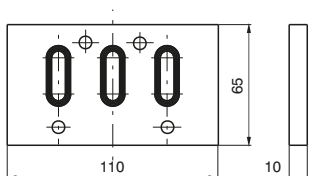

▶ Base adaptor

Coding: 1100.2.1

SIZE
2 = Sizes 2-1
3 = Sizes 3-2



Weight 110 g

1100.2-1

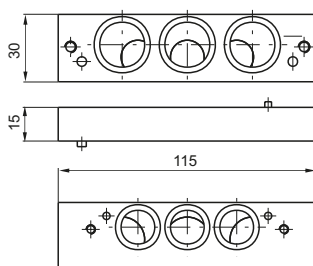

Weight 590 g

1100.3-2

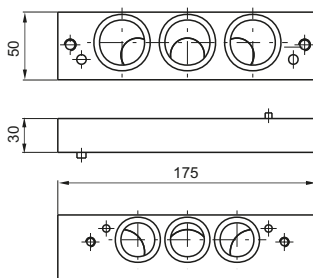



Series 1000 M12 - Size 1, 2 & 3

General

The ISO 5599/1 Solenoid valves Series 1000 M12 are available in three sizes with flow rates from 900 NI/min for size 1 up to the 3600 NI/min for size 3.

The standard features of the ISO valves are still included, however, they are now combined with a M12 electrical connector located in the middle of the valve to manage the electrical signals.

Versions are available to suit valves with both single and double 24VDC solenoids complete with IP65 protection.

All version are supplied with LED indicators

“Shifting time of pneumatic directional control valves or moving parts, logic devices were measured in accordance to ISO 12238:2001, Pneumatic fluid power-Directional control valves-Measurement of shifting time”

Electrical characteristics

Electrical connector M12x1

Protection degree IP65

Input voltage 24VDC

Nominal power 2,3W

LED identification

Monostable version

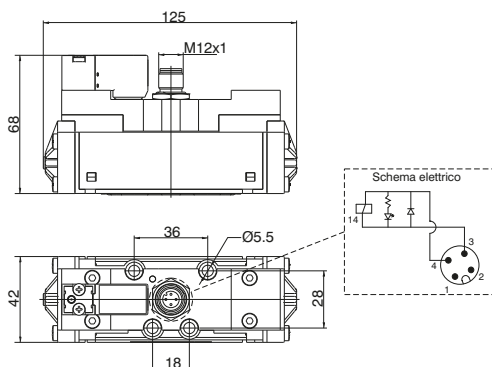

Bistable version

